



Unique pools

Home | 2026

by  ROSA GRES



Índice
Index
Sommaire

Celebramos 20 años, edición especial
Celebrating 20 Years: Special Edition
Célébrons 20 ans : Édition spéciale

04

Colecciones
Collections
Collections

08

Proyectos
Projects
Projets

32

Soluciones Rosa Gres
Rosa Gres Solutions
Solutions Rosa Gres

95

Características técnicas
Technical characteristics
Caractéristiques techniques

107





20 Years

Creating Unique
Pool Experiences

La revolución del mundo de las piscinas

Nuestra marca **Rosa Gres** es reconocida **por ser la primera que propuso el gres porcelánico como material idóneo para revestir piscinas de principio a fin: playa, borde y vaso**. Un **salto pionero** que transformó el sector y cambió por completo la estética tradicional de las piscinas.

Esta **innovación** nos sumergió en el diseño de colores diferentes, una gama atractiva, rica, viva, sugerente: el maravilloso universo de los **colores del agua** que presentamos cada nueva temporada con **Unique Pools** desde hace ya 20 años.

Colores y soluciones, porque hemos desarrollado una completa serie de **piezas de gres porcelánico** que permiten **revestir cada detalle de la piscina y su entorno** de forma armonizada y precisa.

Hoy, **tras 20 años y cientos de proyectos, Unique Pools** mantiene intacto su espíritu innovador y se renueva con cada edición **para inspirar el diseño de piscinas únicas en todo el mundo**.



The revolution in the world of swimming pools

Our brand **Rosa Gres** is recognized **for being the first to propose porcelain stoneware as the ideal material for cladding swimming pools from start to finish: pool deck, edge and tank**. A **pioneering step** that transformed the sector and completely changed the traditional aesthetics of swimming pools.

This **innovation** immersed us in the design of different colours — an attractive, rich, vibrant and evocative range: the wonderful universe of **water colours** that we have been presenting each new season with **Unique Pools** for over 20 years.

Colours and solutions, because we have developed a complete series of **porcelain stoneware pieces** that make it possible **to clad every detail of the pool and its surroundings** in a harmonious and precise way.

Today, after **20 years and hundreds of projects, Unique Pools** keeps its innovative spirit fully intact and is renewed with each edition **to inspire the design of unique swimming pools all over the world**.



La révolution du monde des piscines

Notre marque **Rosa Gres** est reconnue **pour avoir été la première à proposer le grès cérame comme matériau idéal pour le revêtement des piscines de bout en bout : plage, bord et bassin**. Un **pas pionnier** qui a transformé le secteur et changé radicalement l'esthétique traditionnelle des piscines.

Cette **innovation** nous a amenés à explorer la création de couleurs différentes — une gamme attractive, riche, vivante et évocatrice : le merveilleux univers des **couleurs de l'eau** que nous présentons chaque nouvelle saison avec **Unique Pools** depuis plus de 20 ans.

Des couleurs et des solutions, car nous avons développé une série complète de **pièces en grès cérame** permettant de **revêtir chaque détail de la piscine et de son environnement** de manière harmonieuse et précise.

Aujourd'hui, **après 20 ans et des centaines de projets, Unique Pools** conserve intact son esprit d'innovation et se renouvelle à chaque édition **pour inspirer la conception de piscines uniques dans le monde entier**.





Lanzamos **Concept** en 2006 con una paleta de colores que incluía una innovadora propuesta de tonos oscuros para la piscina y su entorno.



We launched **Concept** in 2006 with a color palette that included an innovative range of dark tones for the pool and its surroundings.



Nous avons lancé **Concept** en 2006 avec une palette de couleurs incluant une proposition innovante de tons foncés pour la piscine et son environnement.



Con el **Sistema 9**, creado en 2003 para piscina pública, desarrollamos una nueva solución para construir piscinas desbordantes en residencias privadas. Un paso más en nuestro objetivo de acercar las piscinas de diseño a todo tipo de proyectos.



With **System 9**, created in 2003 for public pools, we developed a new solution for building overflow pools in private residences. One more step toward our goal of bringing design pools to all kinds of projects.



Avec le **Système 9**, créé en 2003 pour les piscines publiques, nous avons développé une nouvelle solution pour construire des piscines à débordement dans des résidences privées. Une étape de plus vers notre objectif de rendre les piscines design accessibles à tous types de projets.

technology & creativity

Gracias a la tecnología conseguimos colores y texturas cada vez más perfectos, con un efecto natural que enamora. **Nuestro gres porcelánico de alta gama se posiciona como una de las mejores soluciones para crear piscinas de diseño.**



Thanks to the technology, we achieve flawless colors and textures with a naturally captivating effect. **Our high-end porcelain stoneware stands out as one of the best solutions for creating designer pools.**



Grâce à la technologie, nous obtenons des couleurs et des textures parfaites, avec un effet naturel qui séduit. **Notre grès cérame haut de gamme s'impose comme l'une des meilleures solutions pour créer des piscines design.**



Nuestros colores se inspiran en la naturaleza y en los paisajes del mundo. Cada temporada presentamos nuevas propuestas: desde **Mystery**, una de las series más demandadas desde 2012, pasando por **Trésor Bali** en 2020, el primer tono exótico que causó sensación en el mercado, hasta hoy, con una **paleta de múltiples estilos** que sigue creciendo.

natural inspiration

Our colors are inspired by nature and the landscapes of the world. Each season, we introduce new collections: from **Mystery**, one of our most sought-after series since 2012, through **Trésor Bali** in 2020, the first exotic shade to make a splash in the market, to today's ever-growing **palette of diverse styles**.



Nos couleurs s'inspirent de la nature et des paysages du monde. Chaque saison, nous présentons de nouvelles collections : de **Mystery**, l'une de nos séries les plus prisées depuis 2012, à **Trésor Bali** en 2020, la première teinte exotique qui a marqué le marché, jusqu'à aujourd'hui avec **une palette de styles variés** qui ne cesse de s'élargir.



Nuestra experiencia y especialización crecen de forma exponencial. Concebimos la piscina como un auténtico oasis de confort y desarrollamos soluciones especiales que lo hacen posible:

Peldaños, plataformas, zonas spa integradas, medias cañas. La **rejilla de gres porcelánico** fue una de las primeras soluciones para piscinas desbordantes del mercado. **Permite revestir una piscina al 100% con gres porcelánico**, aumentando de manera total su calidad, estética y resistencia.

special solutions

Our experience and expertise are growing exponentially. We envision the pool as a true oasis of comfort and develop special solutions that make it possible:

Steps, platforms, integrated spa areas, curved edges. The **porcelain tile grating** was one of the first solutions on the market for deck-level pools. **It allows a swimming pool to be finished with 100% porcelain stoneware**, fully enhancing its quality, aesthetics, and durability.



Notre expérience et notre expertise se développent de manière exponentielle. Nous concevons la piscine comme un véritable oasis de confort et créons des solutions spéciales qui le rendent possible :

Marches, plateformes, zones spa intégrées, demi-cannes. La **grille en grès cérame** a été l'une des premières solutions du marché pour les piscines à débordement. Elle **permet de revêtir une piscine 100 % en grès cérame**, améliorant totalement sa qualité, son esthétique et sa résistance.



porcelain
tile grating



technical
innovation

Las nuevas rejillas de gres porcelánico Flex y Compact reciben el prestigioso premio internacional Architizer A+Awards en 2016. Cada vez más, nuestra cerámica es elegida para piscinas de hoteles, resorts, clubes deportivos y viviendas en todo el mundo.



The new Flex and Compact porcelain tile grating received the prestigious international Architizer A+Awards in 2016. Increasingly, our ceramic solutions are being chosen for swimming pools in hotels, resorts, sports clubs and private residences around the world.



Les nouvelles grilles en grès cérame Flex et Compact ont reçu le prestigieux prix international Architizer A+Awards en 2016. De plus en plus, notre céramique est choisie pour les piscines d'hôtels, de resorts, de clubs sportifs et de résidences privées dans le monde entier.



Nuestro **acabado anti-slip** es uno de los más valorados en el mercado: seguro, cómodo al tacto, fácil de limpiar y con un acabado estético impecable.



Our **anti-slip finish** is one of the most valued on the market: safe, comfortable to the touch, easy to clean, and with an impeccable aesthetic finish.



Notre **finition antidérapante** est l'une des plus appréciées sur le marché : sûre, agréable au toucher, facile à nettoyer et offrant une finition esthétique impeccable.

Con premios internacionales como el **EUSA a la Mejor Piscina Exterior de Europa** en 2019 y presencia en más de 110 países, celebramos 20 años con la mirada puesta en el futuro: **seguir creando soluciones que hagan la vida más confortable**. Gracias por acompañarnos en este camino lleno de inspiración.



GAAB Arquitectes, Spain

With international awards such as the **EUSA for Best Outdoor Pool in Europe in 2019** and a presence in over 110 countries, we celebrate 20 years with our eyes on the future: **continuing to create solutions that make life more comfortable**. Thank you for joining us on this inspiring journey.



GAAB Arquitectes, Spain

Avec des récompenses internationales telles que le **prix EUSA de la Meilleure Piscine Extérieure d'Europe** en 2019 et une présence dans plus de 110 pays, nous célébrons 20 années tournées vers l'avenir : **continuer à créer des solutions qui rendent la vie plus confortable**. Merci de nous accompagner sur ce chemin plein d'inspiration.

Cuore



MM0 Liso Rectificado ⁽¹⁾
97,9 x 97,9 x 1



MM0 Anti-slip Rectificado ⁽²⁾
97,9 x 97,9 x 1



50M Liso Rectificado ⁽¹⁾
48,8 x 97,9 x 1



50M Anti-slip
48,8 x 97,9 x 1



316 Anti-slip
31 x 62,6 x 0,9



Mosaic Anti-slip 310 BH Cuore Verde ⁽³⁾
31,3 x 31,3 (4,9 x 4,9 /u)



Cuore Rosso

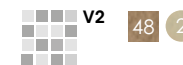

- 97,9 x 97,9 x 1 Liso Rectificado ⁽¹⁾
- 97,9 x 97,9 x 1 Anti-slip Rectificado ⁽²⁾
- 48,8 x 97,9 x 1 Liso Rectificado ⁽¹⁾
- 48,8 x 97,9 x 1 Anti-slip ⁽¹⁾
- 31 x 62,6 x 0,9 Anti-slip

- ⁽¹⁾ Smooth - Rectified
- ⁽¹⁾ Lisse - Rectifié
- ⁽²⁾ Anti-slip - Rectified
- ⁽²⁾ Antidérapant - Rectifié
- ⁽³⁾ Mosaico enmallado de gres porcelánico
- ⁽³⁾ Porcelain mesh-mounted mosaic tiles
- ⁽³⁾ Mosaïque sur maille en grès cérame



Cuore Beige



97,9 x 97,9 x 1 Liso Rectificado ⁽¹⁾
 97,9 x 97,9 x 1 Anti-slip Rectificado ⁽²⁾
 48,8 x 97,9 x 1 Liso Rectificado ⁽¹⁾
 48,8 x 97,9 x 1 Anti-slip
 31 x 62,6 x 0,9 Anti-slip





Cuore Verde



31 x 62,6 x 0,9 Anti-slip
 31,3 x 31,3 (4,9 x 4,9 / u) Mosaic Anti-slip 310 BH ⁽³⁾

Sophy



- 
MM0 Liso Rectificado ⁽¹⁾
 97,9 x 97,9 x 1
- 
MM0 Anti-slip Rectificado ⁽²⁾
 97,9 x 97,9 x 1
- 
50M Liso Rectificado ⁽¹⁾
 48,8 x 97,9 x 1
- 
50M Anti-slip
 48,8 x 97,9 x 1
- 
316 Anti-slip
 31 x 62,6 x 0,9



Sophy White

- 97,9 x 97,9 x 1 Liso Rectificado ⁽¹⁾
- 97,9 x 97,9 x 1 Anti-slip Rectificado ⁽²⁾
- 48,8 x 97,9 x 1 Liso Rectificado ⁽¹⁾
- 48,8 x 97,9 x 1 Anti-slip
- 31 x 62,6 x 0,9 Anti-slip

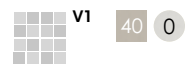

⁽¹⁾ Smooth - Rectified
⁽¹⁾ Lisse - Rectifié
⁽²⁾ Anti-slip - Rectified
⁽²⁾ Antidérapant - Rectifié



Sophy Beige







97,9 x 97,9 x 1 Liso Rectificado ⁽¹⁾
 97,9 x 97,9 x 1 Anti-slip Rectificado ⁽²⁾
 48,8 x 97,9 x 1 Liso Rectificado ⁽¹⁾
 48,8 x 97,9 x 1 Anti-slip
 31 x 62,6 x 0,9 Anti-slip

Sophy Grey



97,9 x 97,9 x 1 Liso Rectificado ⁽¹⁾
 97,9 x 97,9 x 1 Anti-slip Rectificado ⁽²⁾
 48,8 x 97,9 x 1 Liso Rectificado ⁽¹⁾
 48,8 x 97,9 x 1 Anti-slip
 31 x 62,6 x 0,9 Anti-slip

Coral

- 
MM0 Anti-slip Rectificado ⁽¹⁾
 97,9 x 97,9 x 1
- 
50M Anti-slip
 48,8 x 97,9 x 1
- 
316 Anti-slip
 31 x 62,6 x 0,9
- 
Mosaic Anti-slip 310 BH Coral Blue ⁽²⁾
 31,3 x 31,3 (4,9 x 4,9 / u)

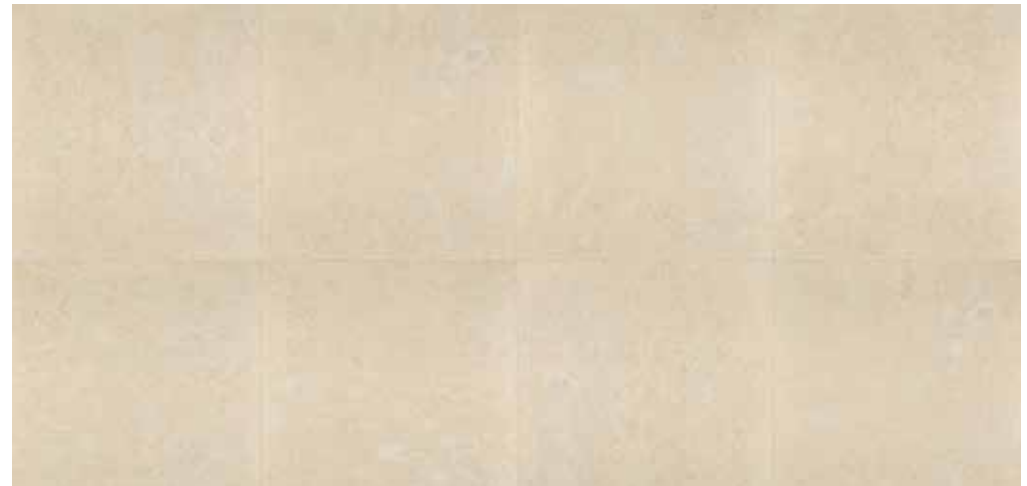

Coral Sand

- 97,9 x 97,9 x 1 Anti-slip Rectificado** ⁽¹⁾
- 48,8 x 97,9 x 1 Anti-slip**
- 31 x 62,6 x 0,9 Anti-slip**



⁽¹⁾ Anti-slip - Rectified
⁽¹⁾ Antidérapant - Rectifié
⁽²⁾ Mosaico enmallado de gres porcelánico
⁽²⁾ Porcelain mesh-mounted mosaic tiles
⁽²⁾ Mosaïque sur maille en grès cérame

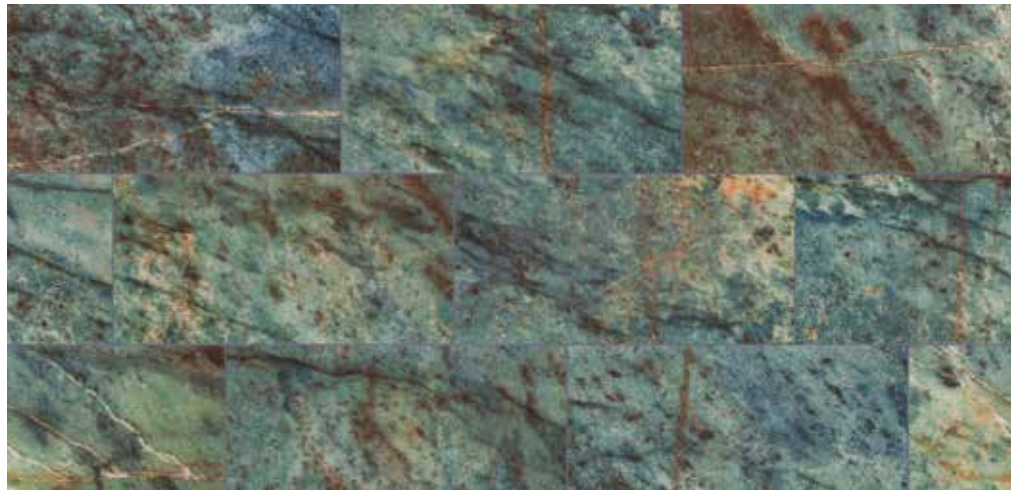
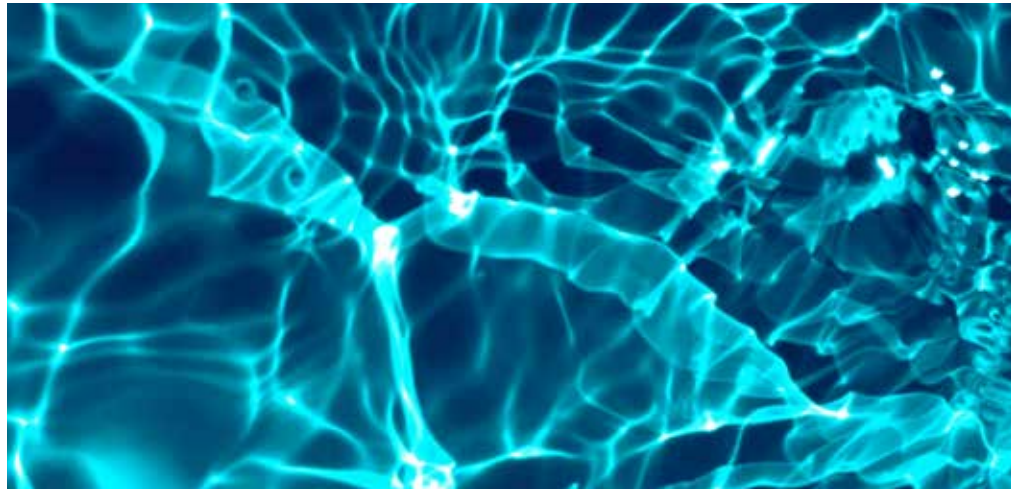

Coral Blue

31 x 62,6 x 0,9 Anti-slip
 31,3 x 31,3 (4,9 x 4,9 / u) Mosaic Anti-slip 310 BH ⁽²⁾



Mythos

Costa Piscinas / Spain



- 50M Liso Rectificado ⁽¹⁾
48,8 x 97,9 x 1
- 50M Anti-slip
48,8 x 97,9 x 1
- 316 Anti-slip
31 x 62,6 x 0,9



Mythos Selene

- 48,8 x 97,9 x 1 Anti-slip
- 48,8 x 97,9 x 1 Liso Rectificado ⁽¹⁾
- 31 x 62,6 x 0,9 Anti-slip

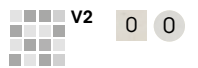

⁽¹⁾ Smooth - Rectified
⁽¹⁾ Lisse - Rectifié



Mythos Dune

48,8 x 97,9 x 1 Anti-slip
 48,8 x 97,9 x 1 Liso Rectificado ⁽¹⁾
 31 x 62,6 x 0,9 Anti-slip









Mythos Antique

48,8 x 97,9 x 1 Anti-slip
 48,8 x 97,9 x 1 Liso Rectificado ⁽¹⁾
 31 x 62,6 x 0,9 Anti-slip

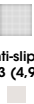

Iconic

- 
MM0 Liso Rectificado ⁽¹⁾
 97,9 x 97,9 x 1
- 
MM0 Anti-slip Rectificado ⁽²⁾
 97,9 x 97,9 x 1
- 
50M Liso Rectificado ⁽¹⁾
 48,8 x 97,9 x 1
- 
50M Anti-slip
 48,8 x 97,9 x 1
- 
50M 2cm Anti-slip ⁽²⁾
 48,8 x 97,9 x 2
- 
316 Anti-slip
 31 x 62,6 x 0,9
- 
316 Pastilla
 31 x 62,6 x 0,9
- 
Mosaic Anti-slip 310 BH ⁽³⁾
 31,3 x 31,3 (4,9 x 4,9 / u)

Piscinas Los Hermanos / Spain



Iconic White

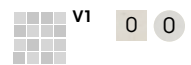

- 97,9 x 97,9 x 1 Liso Rectificado ⁽¹⁾**
- 97,9 x 97,9 x 1 Anti-slip Rectificado ⁽²⁾**
- 48,8 x 97,9 x 1 Liso - Rectificado ⁽¹⁾**
- 48,8 x 97,9 x 1 Anti-slip**
- 48,8 x 97,9 x 2 Anti-slip - Rectificado ⁽²⁾**
- 31 x 62,6 x 0,9 Anti-slip**
- 31 x 62,6 x 0,9 Pastilla**
- 31,3 x 31,3 (4,9 x 4,9 / u) Mosaic Anti-slip 310 BH ⁽³⁾**

⁽¹⁾ Smooth - Rectified
⁽¹⁾ Lisse - Rectifié
⁽²⁾ Anti-slip - Rectified
⁽²⁾ Antidérapant - Rectifié
⁽³⁾ Mosaico enmallado de gres porcelánico
⁽³⁾ Porcelain mesh-mounted mosaic tiles
⁽³⁾ Mosaïque sur maille en grès cérame

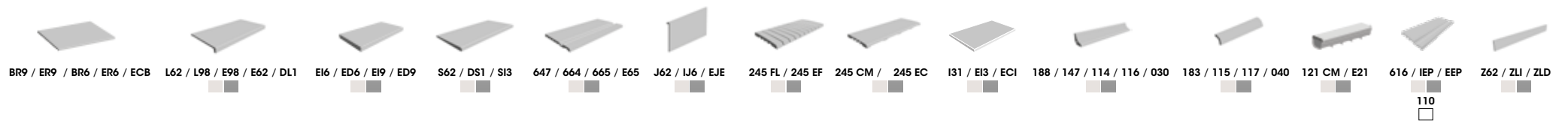

Iconic Grey

- 97,9 x 97,9 x 1 Liso Rectificado ⁽¹⁾
- 97,9 x 97,9 x 1 Anti-slip Rectificado ⁽²⁾
- 48,8 x 97,9 x 1 Liso - Rectificado ⁽¹⁾
- 48,8 x 97,9 x 1 Anti-slip
- 48,8 x 97,9 x 2 Anti-slip - Rectificado ⁽²⁾
- 31 x 62,6 x 0,9 Anti-slip
- 31 x 62,6 x 0,9 Pastilla

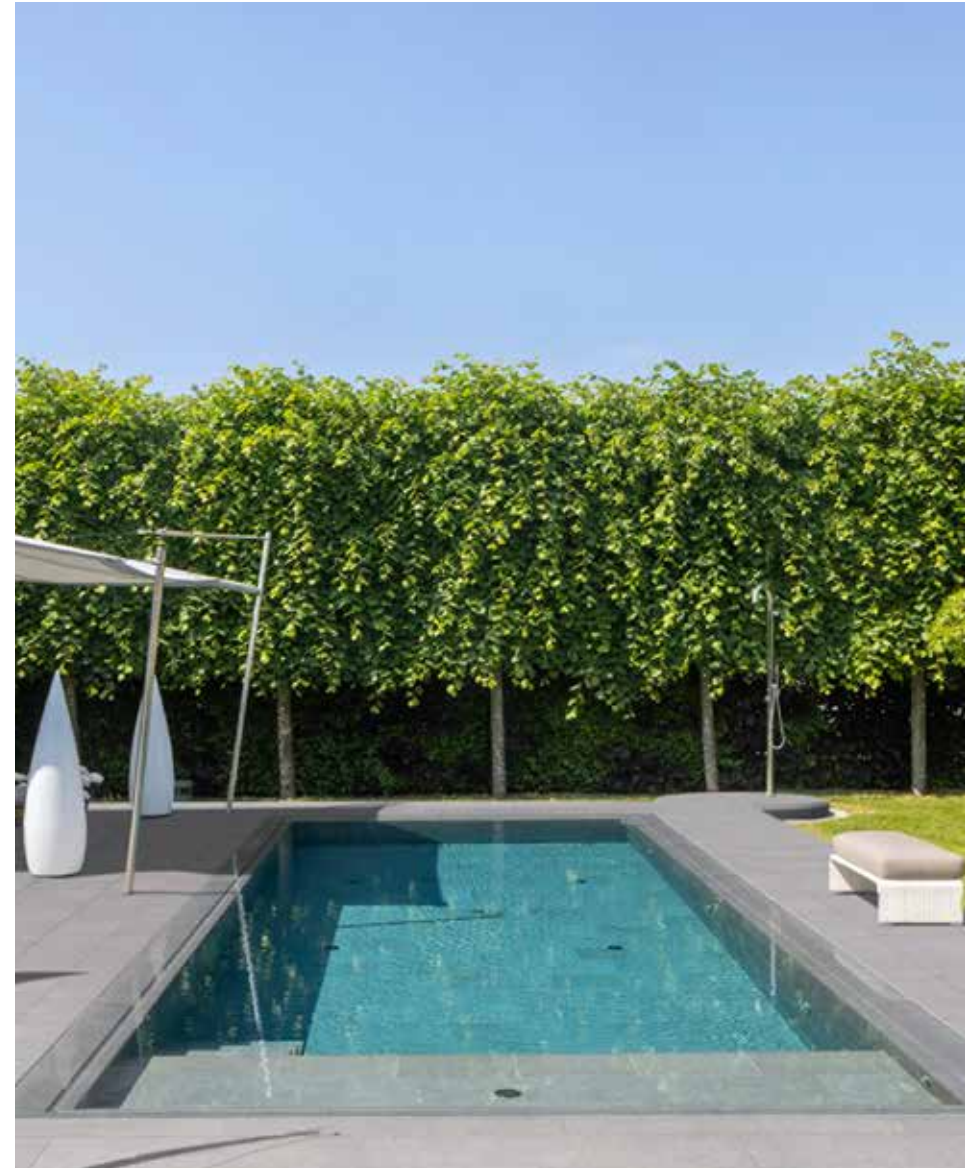

Trésor

Photograph: Jordi Miralles / Aquablau / Spain



Trésor Bali

31 x 62,6 x 0,9 Anti-slip
31,3 x 31,3 (4,9 x 4,9 /u) Mosaic Anti-slip 310 BH ⁽¹⁾



316 Anti-slip
31 x 62,6 x 0,9

Mosaic Anti-slip 310 BH ⁽¹⁾
31,3 x 31,3 (4,9 x 4,9 /u)

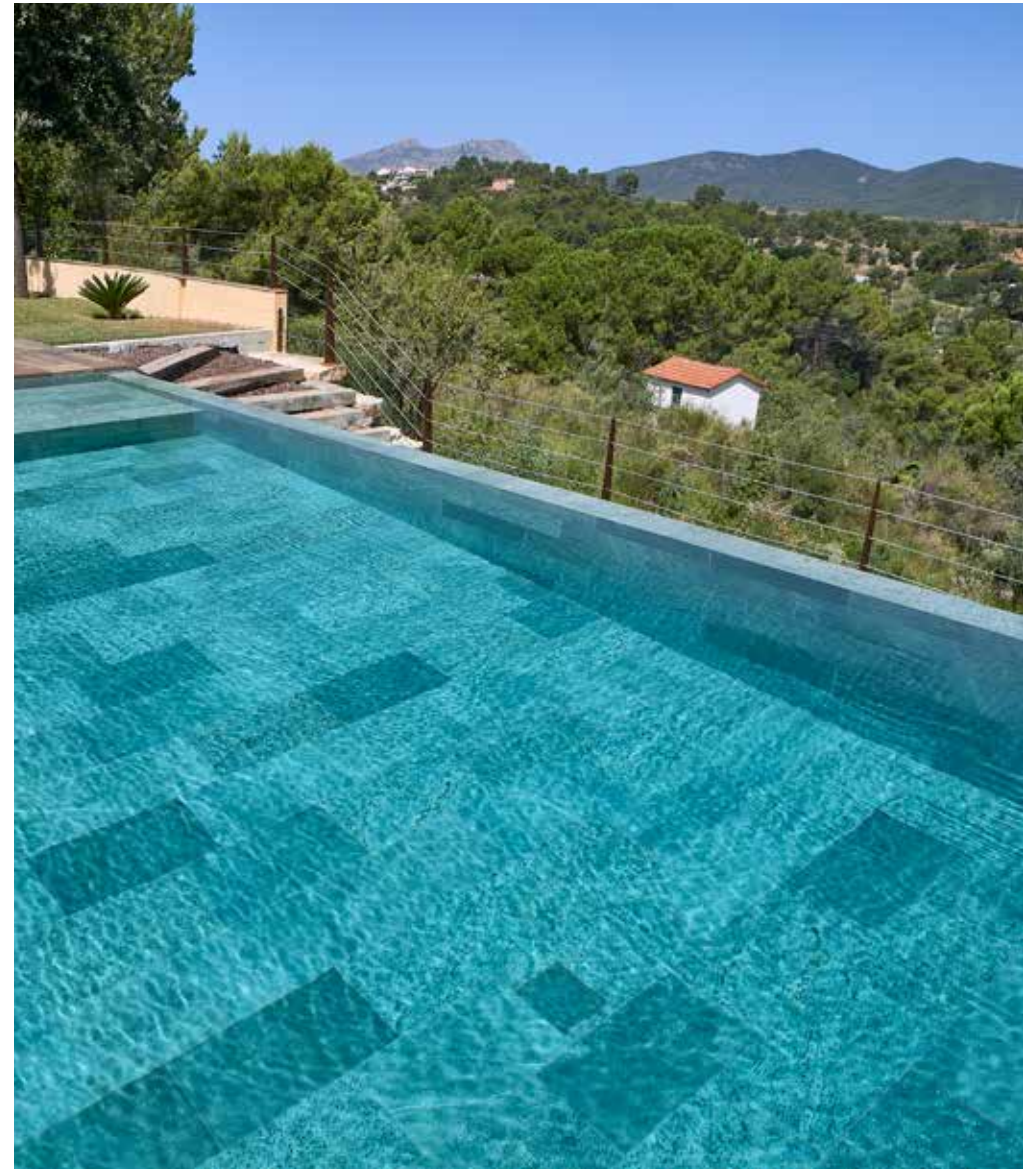

⁽¹⁾ Mosaico enmallado de gres porcelánico
⁽¹⁾ Porcelain mesh-mounted mosaic tiles
⁽¹⁾ Mosaïque sur maille en grès cérame

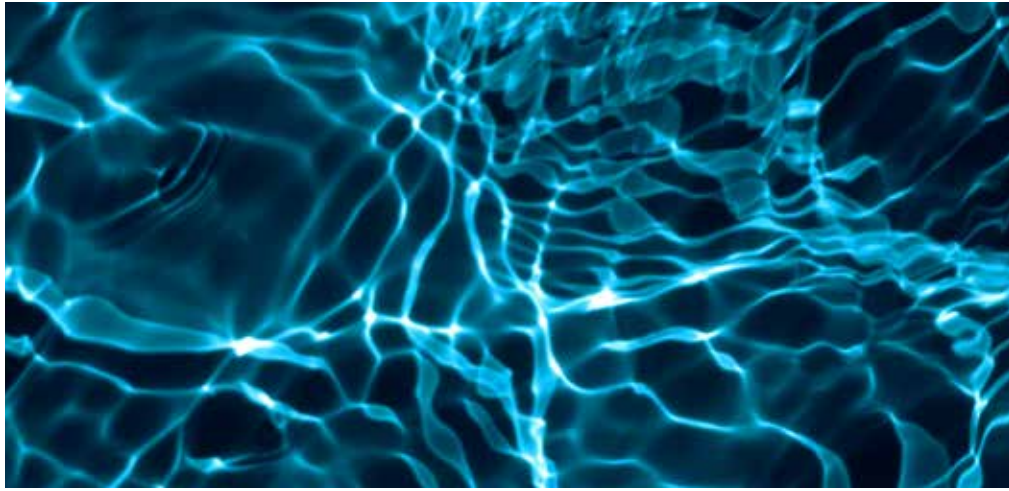
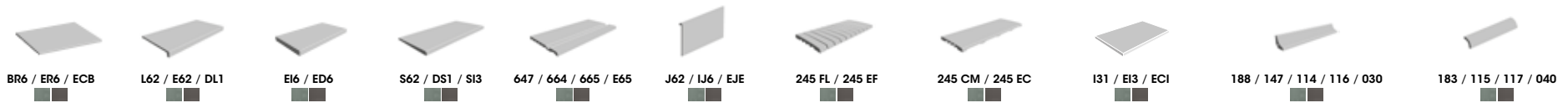

Trésor Java

31 x 62,6 x 0,9 Anti-slip
 31,3 x 31,3 (4,9 x 4,9 / u) Mosaic Anti-slip 310 BH ⁽¹⁾

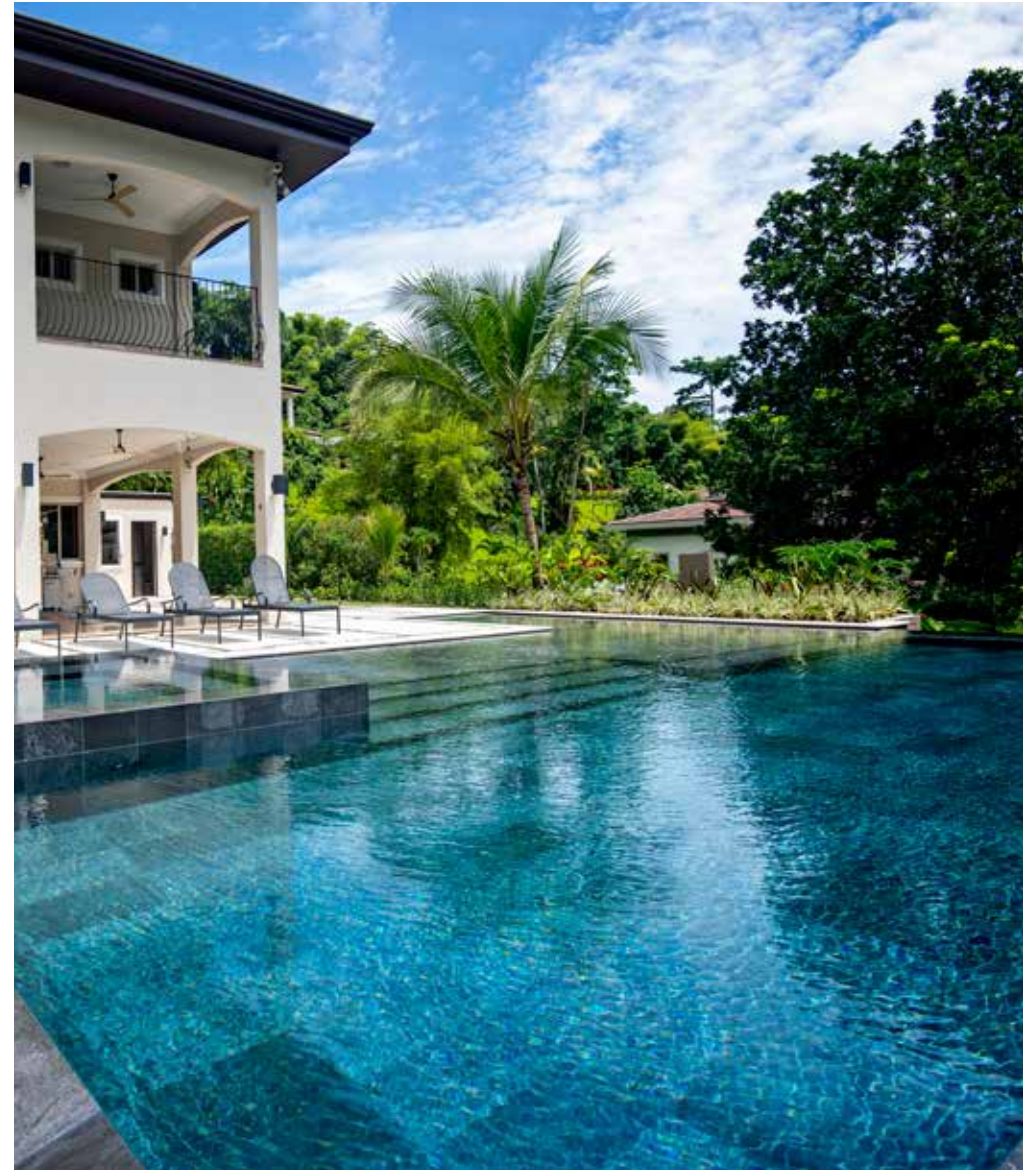

Serena Mix

316 Anti-slip
31 x 62,6 x 0,9

Mosaic Anti-slip 310 BH ⁽¹⁾
31,3 x 31,3 (4,9 x 4,9 / u)

Silver Fox / Dubai, EAU



⁽¹⁾ Mosaico enmallado de gres porcelánico
⁽¹⁾ Porcelain mesh-mounted mosaic tiles
⁽¹⁾ Mosaïque sur maille en grès cérame

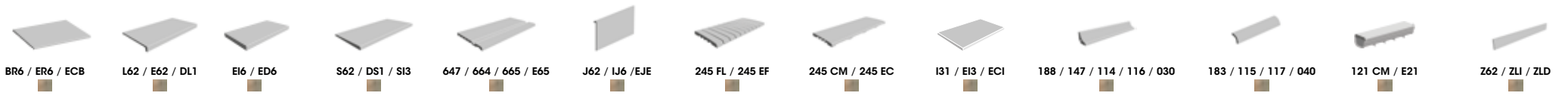

Photograph: Jordi Miralles / Pavisoto / Spain



Serena Mix

31 x 62,6 x 0,9 Anti-slip
 31,3 x 31,3 (4,9 x 4,9 /u) Mosaic Anti-slip 310 BH ⁽¹⁾



Serena

50M Liso Rectificado ⁽¹⁾
48,8 x 97,9 x 1

50M Anti-slip
48,8 x 97,9 x 1

316 Anti-slip
31 x 62,6 x 0,9



Serena Bianco

48,8 x 97,9 x 1 Liso Rectificado ⁽¹⁾
48,8 x 97,9 x 1 Anti-slip
31 x 62,6 x 0,9 Anti-slip



Serena Ocra

48,8 x 97,9 x 1 Liso Rectificado ⁽¹⁾
48,8 x 97,9 x 1 Anti-slip
31 x 62,6 x 0,9 Anti-slip



⁽¹⁾ Smooth - Rectified
⁽¹⁾ Lisse - Rectifié

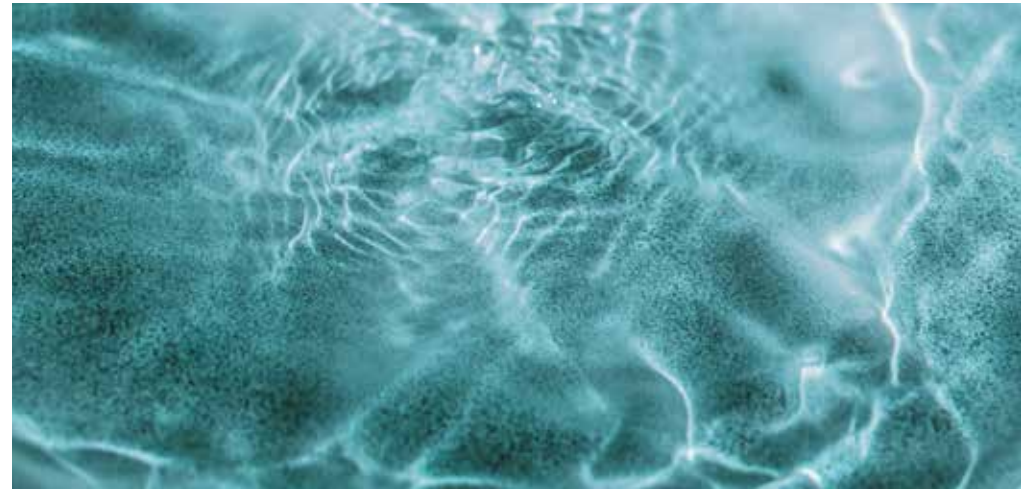

Serena Griggio

31 x 62,6 x 0,9 Anti-slip



Serena Nero

31 x 62,6 x 0,9 Anti-slip



Pietro



Pietro White

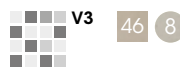

- 48,8 x 97,9 x 1 Liso - Rectificado ⁽¹⁾
- 48,8 x 97,9 x 1 Anti-slip
- 48,8 x 97,9 x 2 Anti-slip - Rectificado ⁽²⁾
- 31 x 62,6 x 0,9 Anti-slip
- 31 x 62,6 x 0,9 Pastilla
- 31,3 x 31,3 (4,9 x 4,9 /u) Mosaic Anti-slip 310 BH ⁽³⁾

Pietro Golden

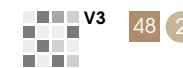

- 48,8 x 97,9 x 1 Liso - Rectificado ⁽¹⁾
- 48,8 x 97,9 x 1 Anti-slip
- 48,8 x 97,9 x 2 Anti-slip - Rectificado ⁽²⁾
- 31 x 62,6 x 0,9 Anti-slip
- 31 x 62,6 x 0,9 Pastilla
- 31,3 x 31,3 (4,9 x 4,9 /u) Mosaic Anti-slip 310 BH ⁽³⁾

- ⁽¹⁾ Smooth - Rectified
- ⁽¹⁾ Lisse - Rectifié
- ⁽²⁾ Anti-slip - Rectified
- ⁽²⁾ Antidérapant - Rectifié
- ⁽³⁾ Mosaico enmallado de Gres porcelánico
- ⁽³⁾ Porcelain mesh-mounted mosaic tiles
- ⁽³⁾ Mosaïque sur maille en grès cérame

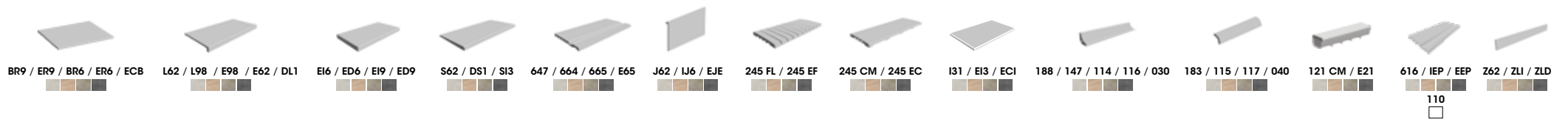

Pietro Grey

48,8 x 97,9 x 1 Anti-slip
 31 x 62,6 x 0,9 Anti-slip
 31 x 62,6 x 0,9 Pastilla



Pietro Dark

48,8 x 97,9 x 1 Anti-slip
 31 x 62,6 x 0,9 Anti-slip
 31 x 62,6 x 0,9 Pastilla



Mystery

50M Liso Rectificado ⁽¹⁾
 48,8 x 97,9 x 1

50M Anti-slip
 48,8 x 97,9 x 1

316 Anti-slip
 31 x 62,6 x 0,9



316 Liso
 31 x 62,6 x 0,9

Mosaic Anti-slip 310 BH ⁽³⁾
 31,3 x 31,3 (4,9 x 4,9 / u)

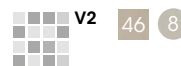

Mystery White

48,8 x 97,9 x 1 Anti-slip
48,8 x 97,9 x 1 Liso Rectificado ⁽¹⁾
31 x 62,6 x 0,9 Anti-slip
31 x 62,6 x 0,9 Liso ⁽²⁾
31,3 x 31,3 (4,9 x 4,9 / u) Mosaic Liso ⁽²⁾ **310 BH** ⁽³⁾



Mystery Sand

48,8 x 97,9 x 1 Anti-slip
48,8 x 97,9 x 1 Liso Rectificado ⁽¹⁾
31 x 62,6 x 0,9 Anti-slip
31 x 62,6 x 0,9 Liso ⁽²⁾
31,3 x 31,3 (4,9 x 4,9 / u) Mosaic Liso ⁽²⁾ **310 BH** ⁽³⁾

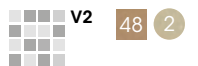

⁽¹⁾ Smooth - Rectified
⁽¹⁾ Lisse - Rectifié
⁽²⁾ Smooth
⁽²⁾ Lisse
⁽³⁾ Mosaico enmallado de gres porcelánico
⁽³⁾ Porcelain mesh-mounted mosaic tiles
⁽³⁾ Mosaïque sur maille en grès cérame

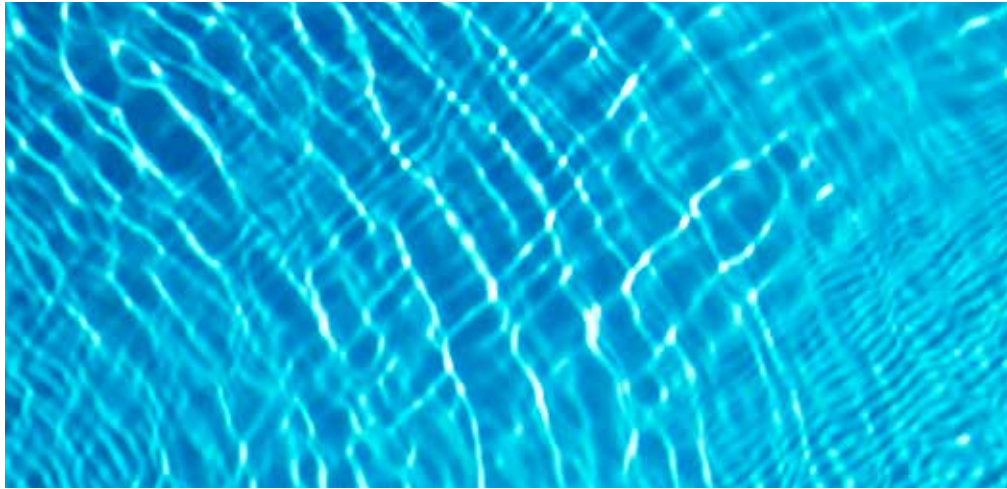
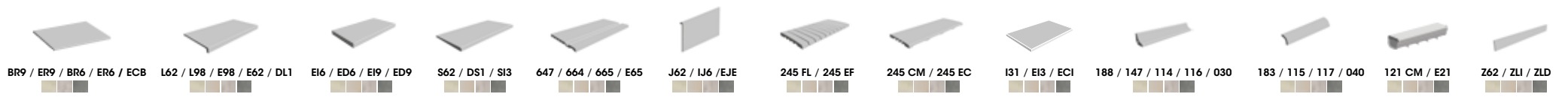

Mystery Grey



48,8 x 97,9 x 1 Anti-slip
 48,8 x 97,9 x 1 Liso Rectificado ⁽¹⁾
 31 x 62,6 x 0,9 Anti-slip
 31 x 62,6 x 0,9 Liso ⁽²⁾
 31,3 x 31,3 (4,9 x 4,9 /u) Mosaic Liso ⁽²⁾ 310 BH ⁽³⁾

Mystery Blue Stone



48,8 x 97,9 x 1 Anti-slip
 48,8 x 97,9 x 1 Liso Rectificado ⁽¹⁾
 31 x 62,6 x 0,9 Anti-slip
 31 x 62,6 x 0,9 Liso ⁽²⁾
 31,3 x 31,3 (4,9 x 4,9 /u) Mosaic Liso ⁽²⁾ 310 BH ⁽³⁾

Alma

Oscar Corona / Spain



199 Anti-slip
19,4 x 97,9 x 1



Piscinas Mayipool / Spain



Alma Pure

19,4 x 97,9 x 1 Anti-slip



Alma Honey

19,4 x 97,9 x 1 Anti-slip

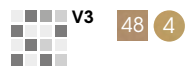



BR9 / ER9 / ECB



L98 / E98 / DL2



E19 / ED9



245 FL / 245 EF



245 CM / 245 EC



121 CM / E21



Z62 / ZLI / ZLD



Piscinas Dome / Spain



Alma Forest

19,4 x 97,9 x 1 Anti-slip



V3



9

9

Alma Mist

19,4 x 97,9 x 1 Anti-slip



V3



8

8

Stela

EUC Piscines / Spain



Iraqua Piscinas / Spain

199 Anti-slip
19,4 x 97,9 x 1



Stela White

19,4 x 97,9 x 1 Anti-slip



Stela Golden

19,4 x 97,9 x 1 Anti-slip

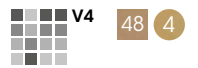



BR9 / ER9 / ECB



L98 / E98 / DL2



E19 / ED9



245 FL / 245 EF



245 CM / 245 EC



121 CM / E21



Z62 / ZLI / ZLD



Crystalline pools & Spas / Chipre



Photograph: Jordi Miralles / Design: Indissey / Spain



Stela Grey

19,4 x 97,9 x 1 Anti-slip



V4



Stela Dark

19,4 x 97,9 x 1 Anti-slip



V4





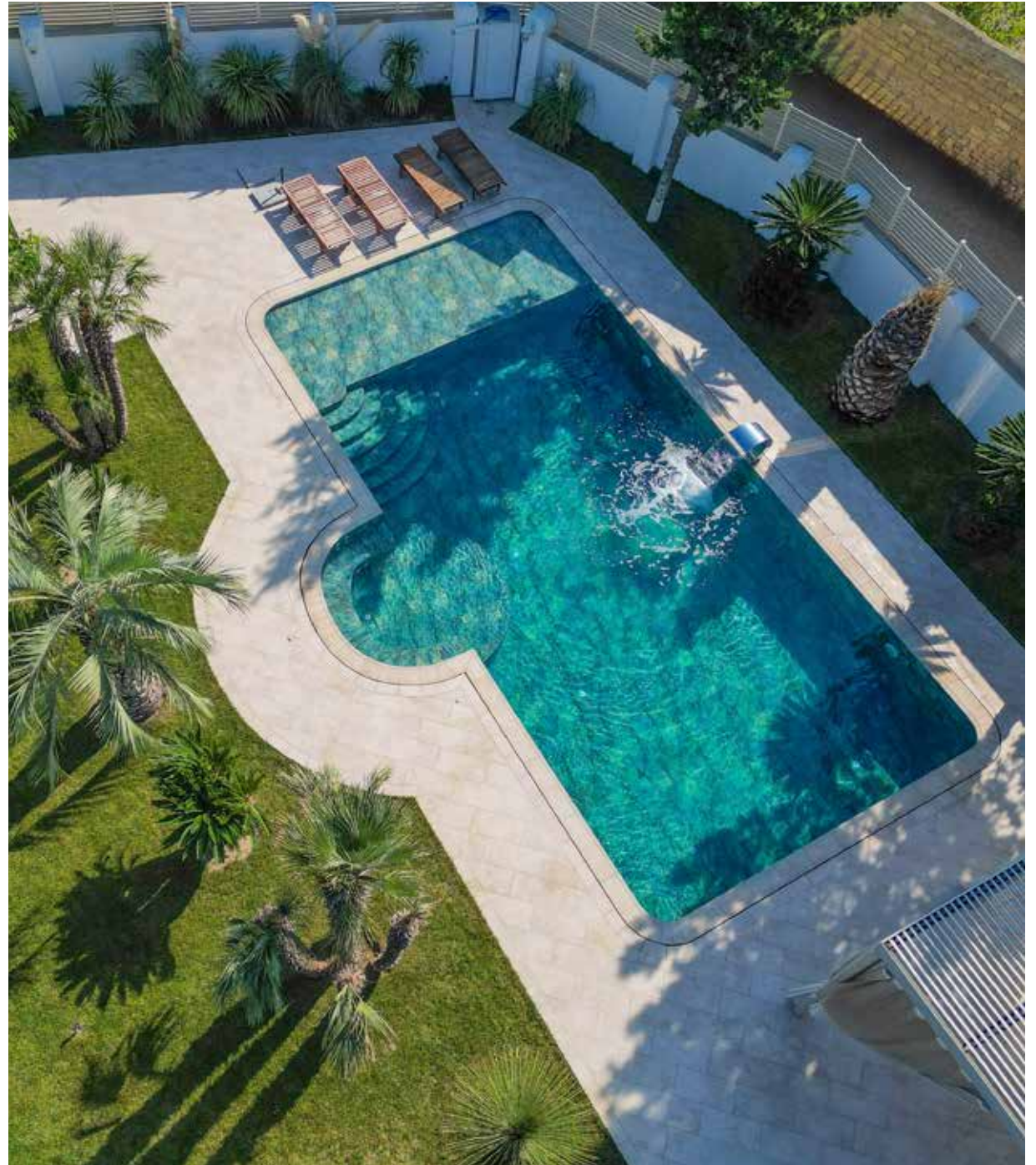





home *wellness*

El acabado de nuestro gres porcelánico antideslizante es suave y muy agradable al contacto con la piel. Un material ideal para crear espacios confortables.

The finish of our anti-slip porcelain tiles is smooth and delightful to the touch, making it an ideal material for creating comfortable spaces.

La finition de nos carreaux en grès cérame antidérapants est douce et très agréable au contact de la peau, un matériau idéal pour créer des espaces confortables.

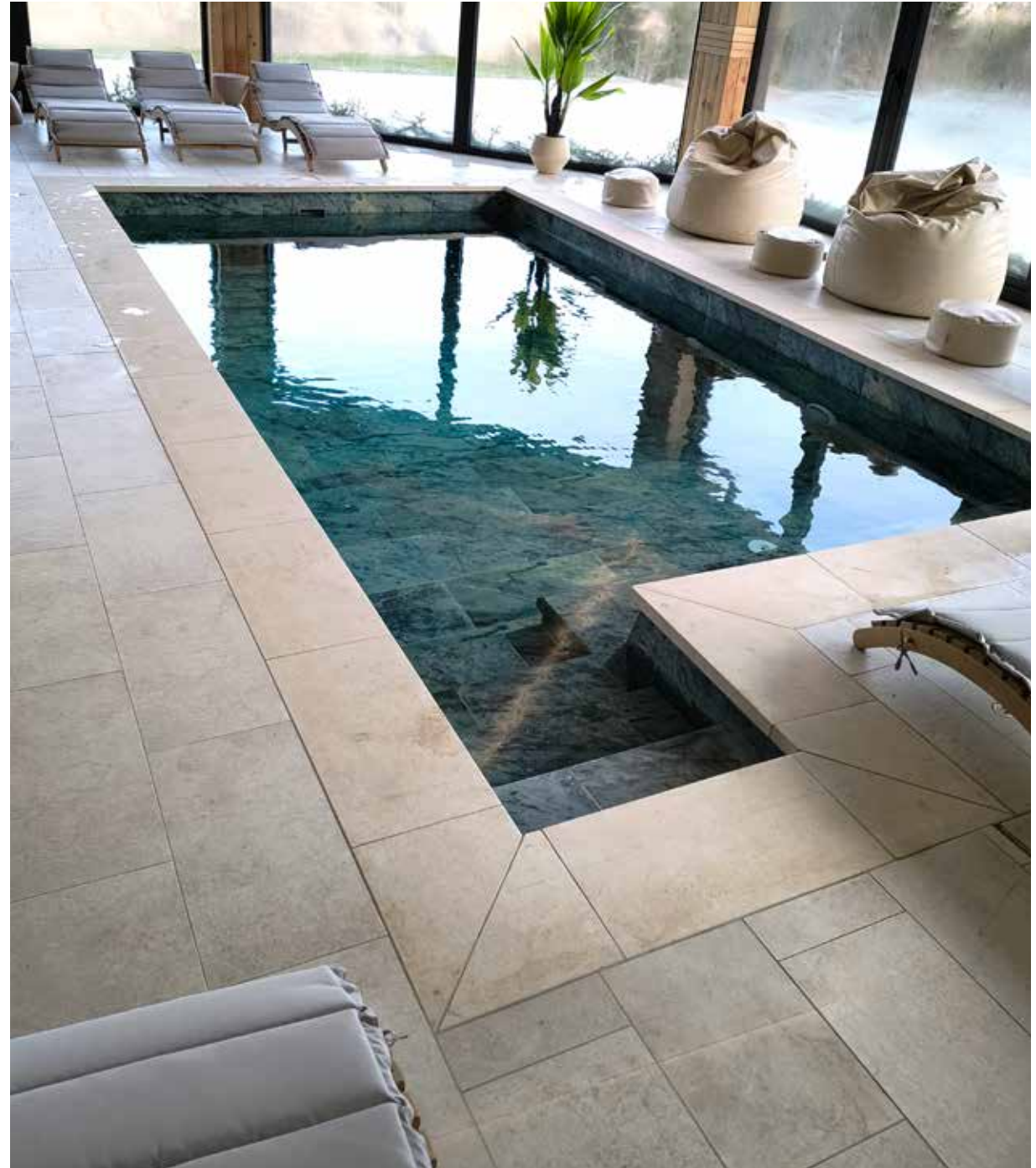

Coral Blue

Russia





water color *ideas*

Inspirado en los fondos marinos, nuestro nuevo Coral Blue revela un color de agua azul turquesa brillante, intenso y fascinante. Es 100 % cautivador.

Inspired by the seabed, our new Coral Blue reveals a bright, intense, and fascinating turquoise-blue water color. It is 100 % captivating.

Inspiré par les fonds marins, notre nouveau Coral Blue révèle une couleur d'eau turquoise brillante, intense et fascinante. Il est 100 % captivant.





building *secrets*

Las piscinas poco profundas son más seguras y fáciles de construir. Aquí, además, el vaso incorpora escaleras y plataformas, todo pensado para disfrutar al máximo del agua.

Shallow pools are safer and easier to build. Moreover, here, the pool includes stairs and platforms, all designed to make the most of your time in the water.

Les piscines peu profondes sont plus sûres et plus faciles à construire. De plus, ici, le bassin comprend des escaliers et des plateformes, tout est pensé pour profiter au maximum de l'eau.

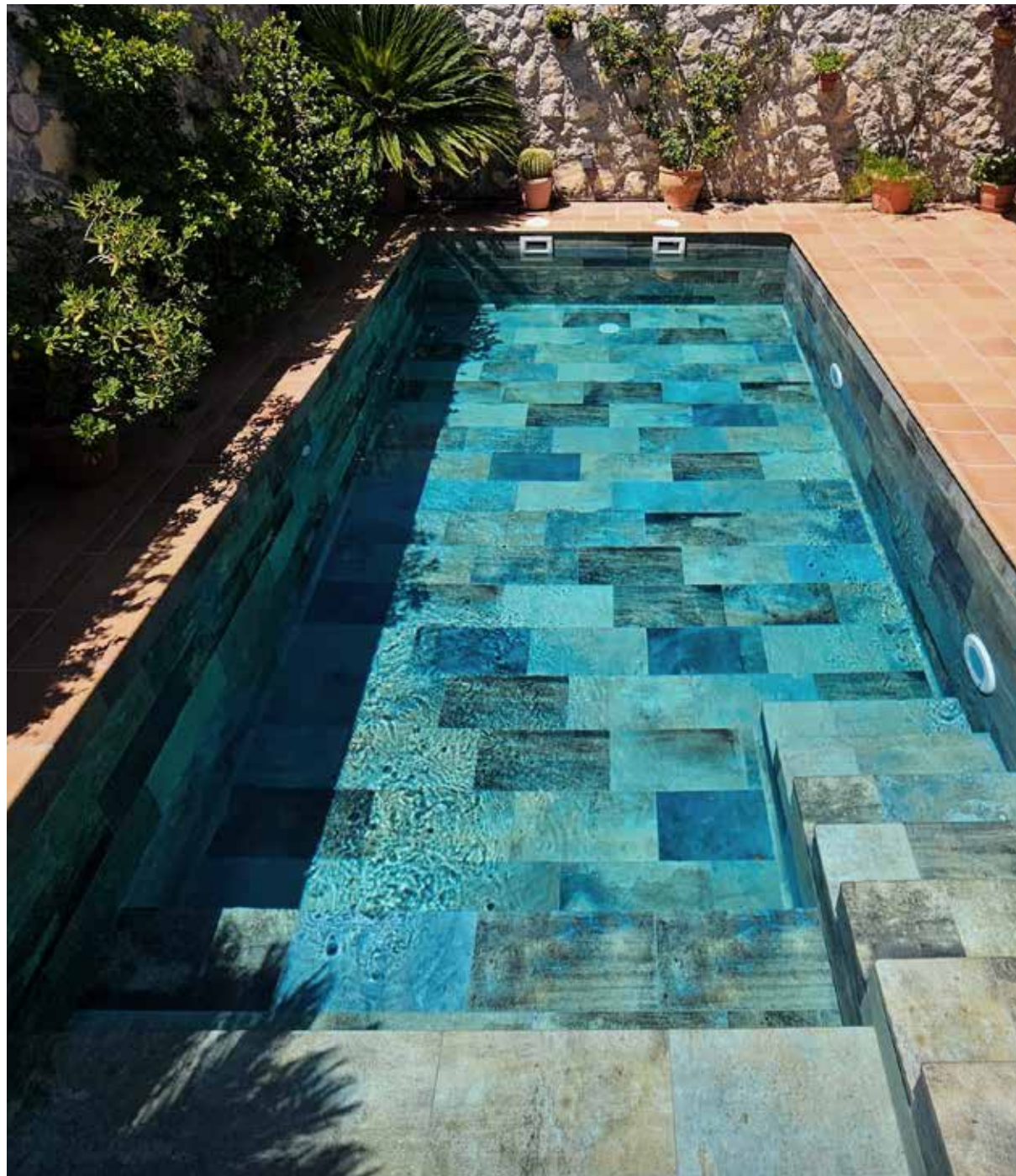



small pool *tips*

Esta piscina destaca por sus colores y por la integración de elementos como el banco y las escaleras triangulares, pensados para adaptarse perfectamente al espacio.

This pool stands out for its colors and the integration of elements such as the bench and triangular steps, designed to fit the space perfectly.

Cette piscine se distingue par ses couleurs et par l'intégration d'éléments tels que le banc et les escaliers triangulaires, conçus pour s'adapter parfaitement à l'espace.

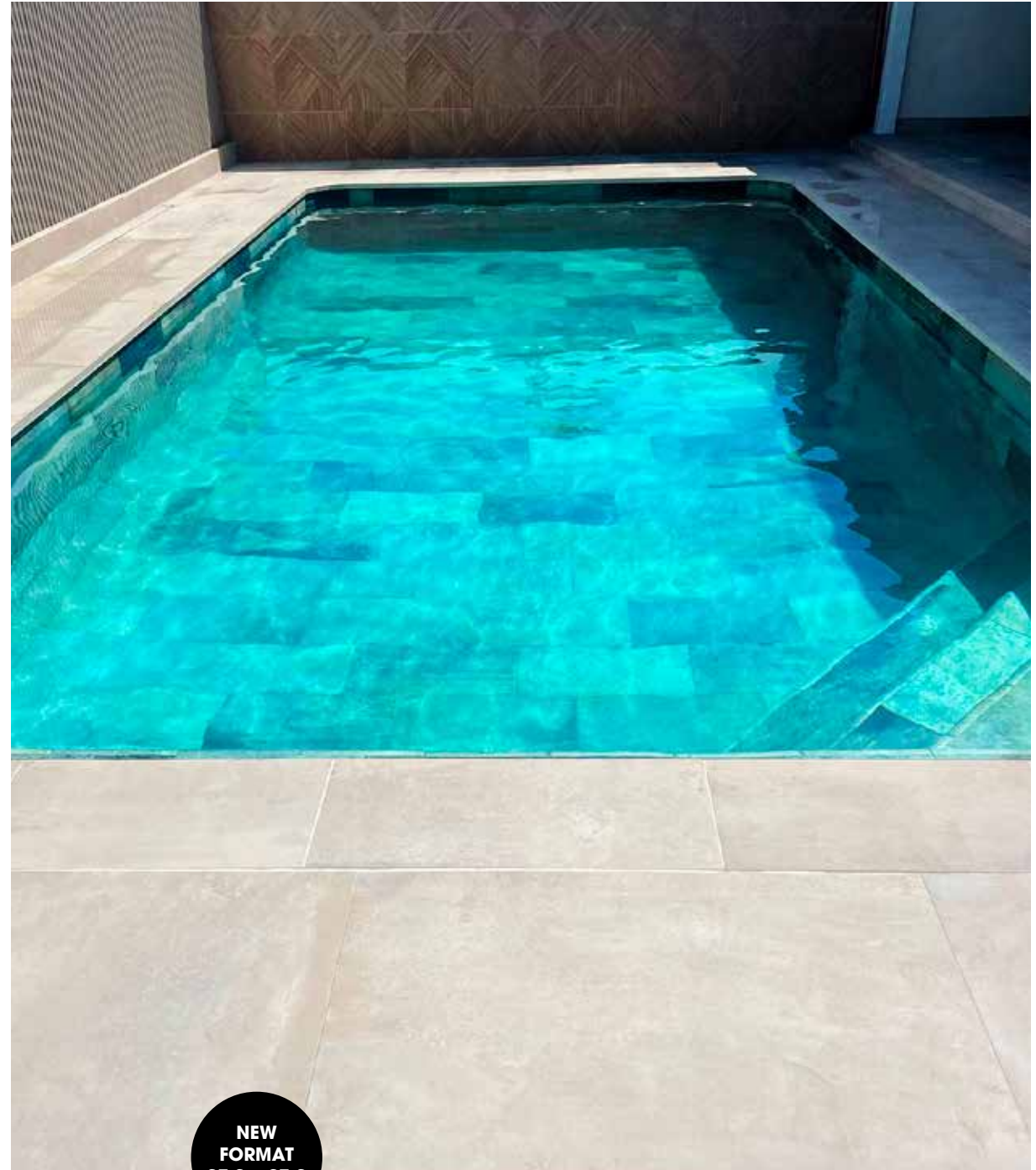

NEW
FORMAT
97,9 x 97,9





total harmony

Una piscina pequeña en un espacio 100% coordinado.
La luminosidad del color de la cerámica y el diseño integrado realzan la sensación de armonía y amplitud.

A small pool in a fully coordinated space.
The brightness of the tiles and the integrated design enhance the sense of harmony and spaciousness.

Une petite piscine dans un espace entièrement coordonné.
La luminosité des carreaux et le design intégré renforcent la sensation d'harmonie et d'espace.



NEW
FORMAT
97,9 x 97,9





calm & chic

Cada detalle está pensado para crear un espacio cómodo, moderno y elegante: amplia plataforma, escaleras, zona spa y una terraza integrada junto al agua de la piscina. Un oasis **Mythos Selene**.

Every detail is designed to create a comfortable, modern, and elegant space: a spacious platform, steps, a spa area, and an integrated terrace by the pool. A **Mythos Selene** oasis.

Chaque détail est pensé pour créer un espace confortable, moderne et élégant : une grande plateforme, des escaliers, un espace spa et une terrasse intégrée au bord de la piscine. Une oasis **Mythos Selene**.







a classic *look*

Elegir un color singular es un detalle esencial para crear un proyecto único. Mythos Selene es una textura de mármol perfecta para diseños de inspiración clásica.

Choosing a distinctive color is an essential detail for creating a unique project. Mythos Selene is a marble texture that's perfect for classic-inspired designs.

Choisir une couleur singulière est un détail essentiel pour créer un projet unique. Mythos Selene est une texture de marbre parfaite pour des designs d'inspiration classique.







mediterranean *essence*

Un color y un paisaje que encajan a la perfección.
 Una piscina infinity con escaleras y plataforma integradas.
 Un viaje al estilo Mediterráneo más cool y refrescante.

A colour and a landscape in perfect harmony.
 An infinity pool with integrated steps and platform.
 A journey into the coolest, most refreshing
 Mediterranean style.

Une couleur et un paysage en parfaite harmonie.
 Une piscine à débordement aux escaliers et à la
 plateforme intégrés. Une véritable invitation
 à la fraîcheur, inspirée du style méditerranéen.







design *inspiration*

Una piscina espectacular, con un lateral infinity y un lateral desbordante acabado con la rejilla Compact. Incluye banco, escaleras, zona de relax y plataforma.

A spectacular pool, featuring one infinity edge and one overflow edge finished with the Compact grating, including a bench, steps, a relaxation area, and a platform.

Une piscine spectaculaire, avec un côté infinity et un côté débordant, finition grille Compact, intégrant un banc, des escaliers, une zone de détente et une plateforme.







flow design

Piscina desbordante y ovalada, construida con nuestro Sistema Prestige y la rejilla Flex, una solución diseñada para revestir las curvas de forma perfecta.

Oval overflow pool built with our Prestige System and Flex grating, a solution designed to perfectly line curved shapes.

Piscine débordante et ovale, construite avec notre Système Prestige et la grille Flex, une solution conçue pour habiller parfaitement les courbes.







jewel pool

El diseño y los detalles artísticos de un proyecto único, acabado con nuestra **solución Infinity**. La paleta de colores — Trésor Bali y madera cerámica — se inspira en los elementos naturales del paisaje. Espectacular.

The design and artistic details of a unique project, finished with our Infinity solution. The color palette — Trésor Bali and ceramic wood — is inspired by the natural elements of the landscape. Spectacular.

Le design et les détails artistiques d'un projet unique, réalisés avec notre solution Infinity. La palette de couleurs — Trésor Bali et bois céramique — s'inspire des éléments naturels du paysage. Spectaculaire.

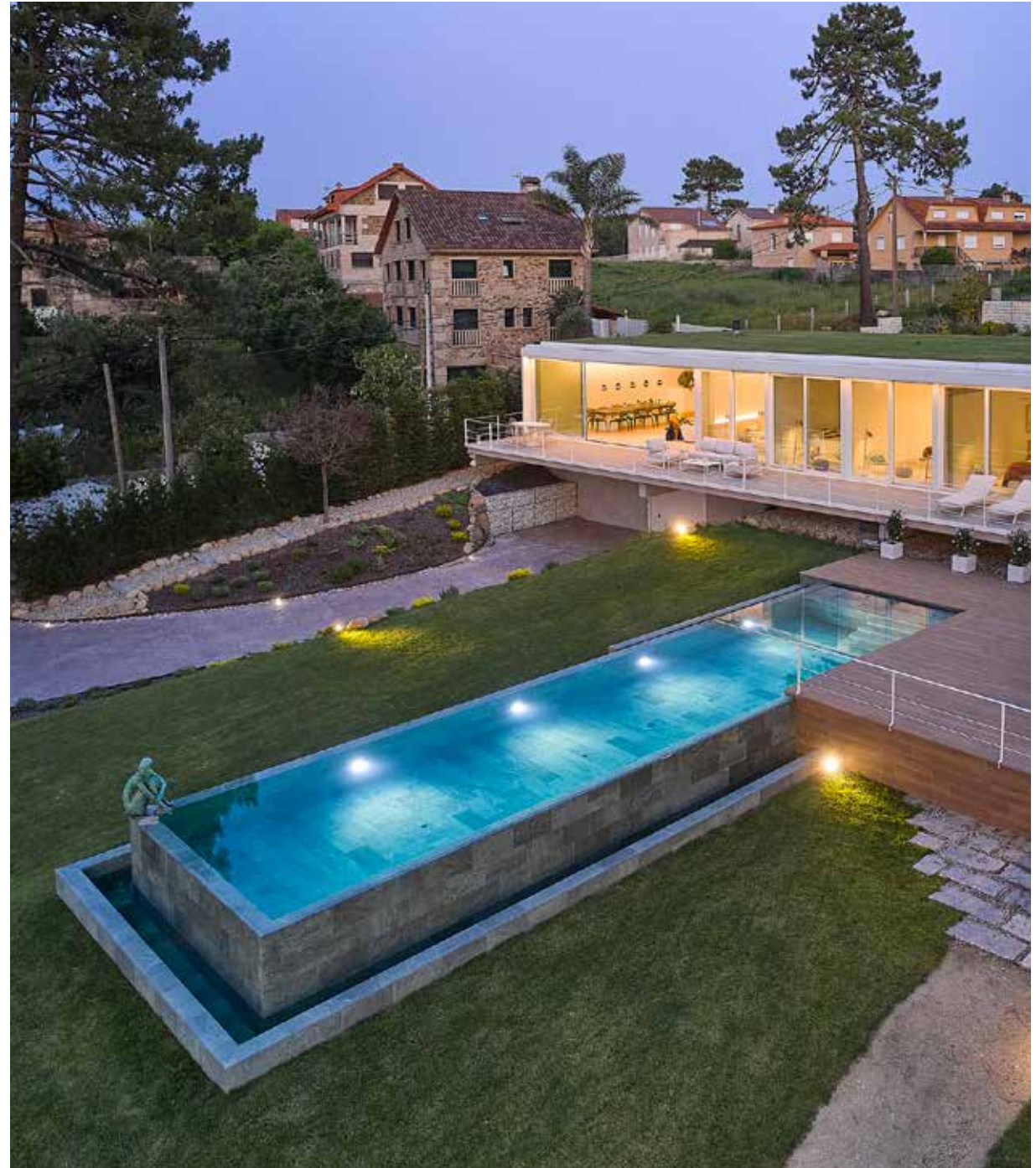



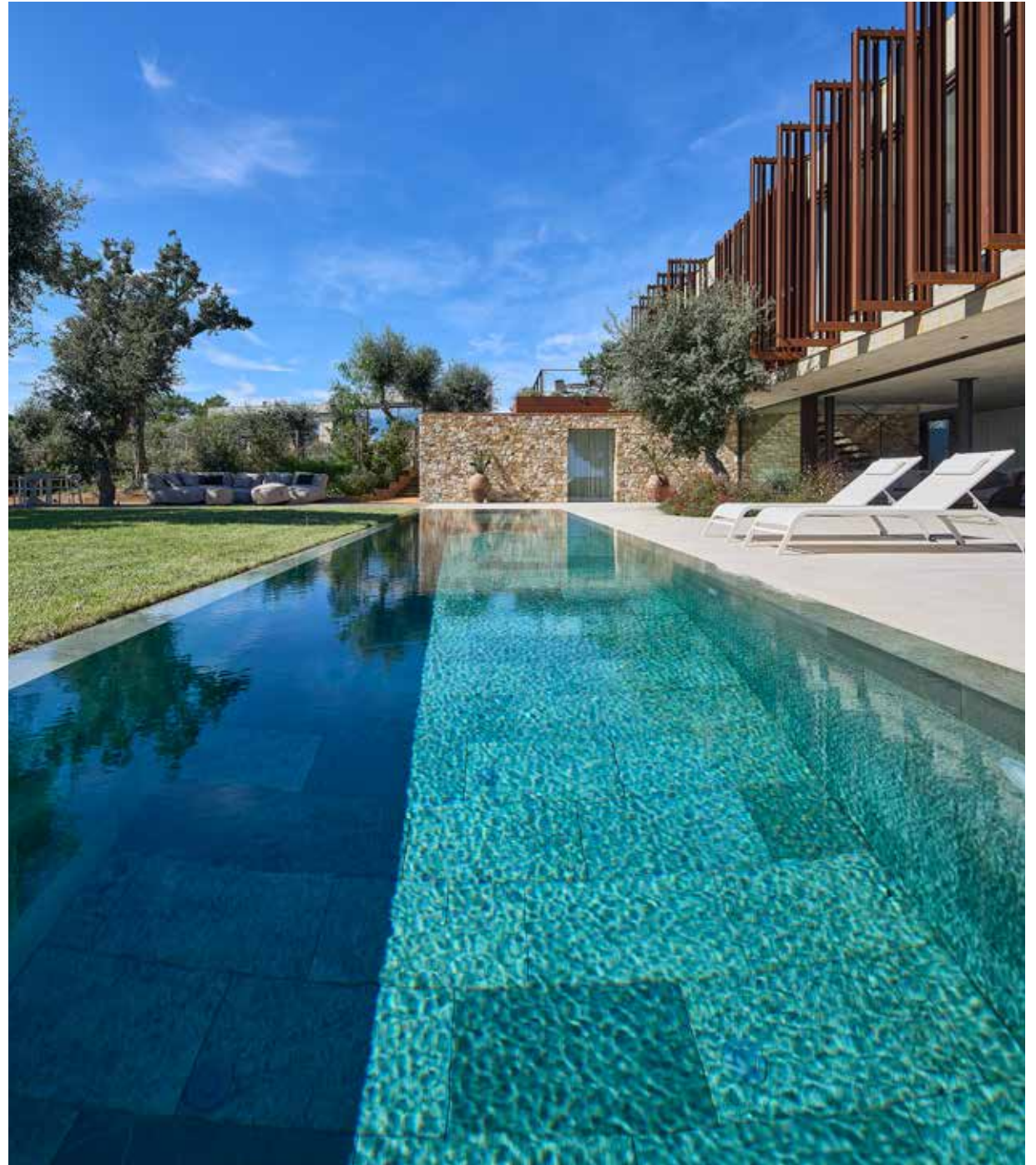





architectural *concept*

Piscina construida con nuestro **Sistema Smart**: un sistema desbordante oculto que ayuda a reducir las salpicaduras del agua sobre la terraza y aporta una estética muy depurada.

Pool built with our **Smart System**, a hidden overflow system that helps minimize splashes on the terrace while providing a sleek, refined look.

Piscine construite avec notre **Système Smart**, un système à débordement caché qui permet de réduire les éclaboussures sur la terrasse tout en offrant une esthétique très raffinée.

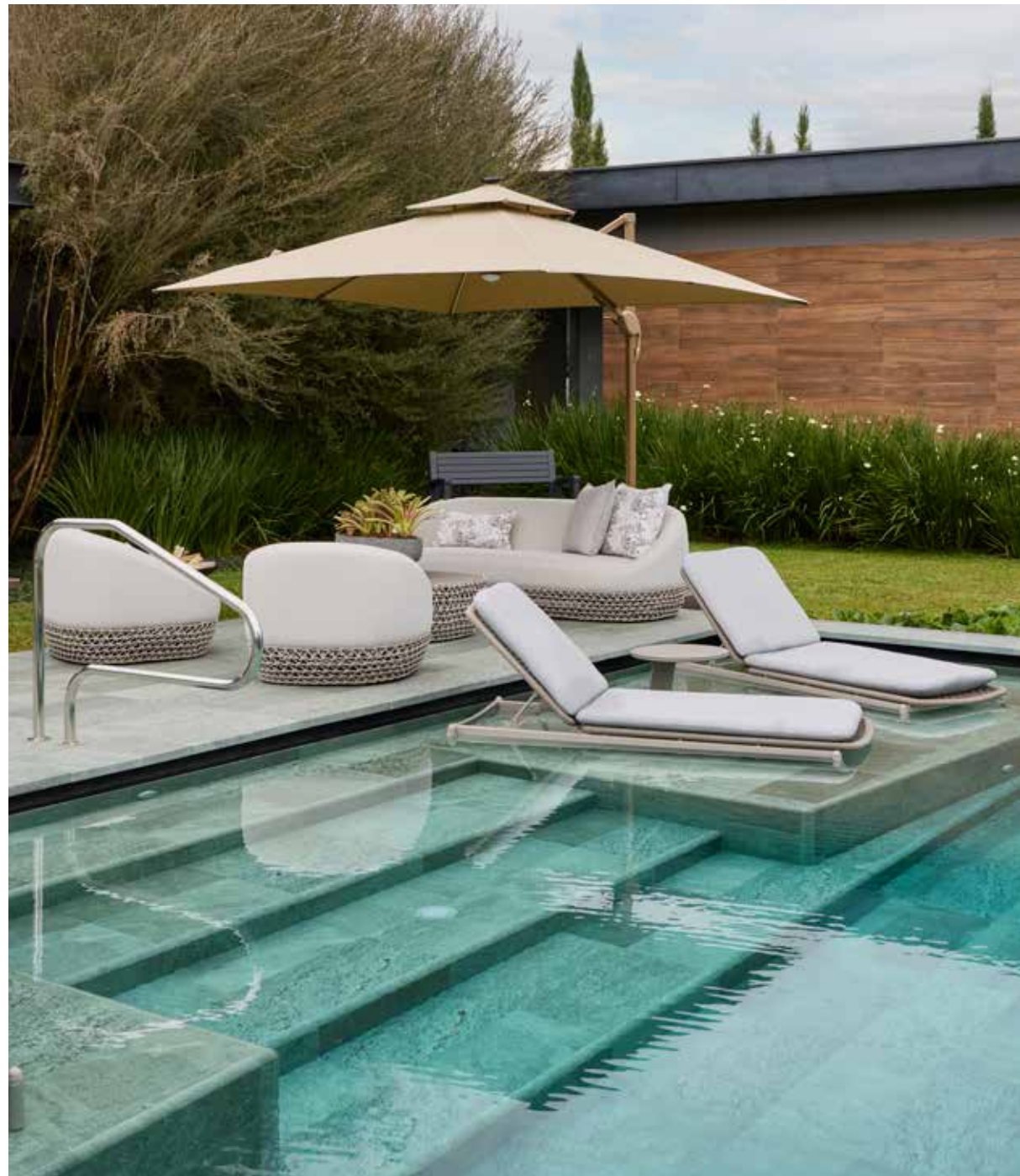





balance *style*

Crear un ambiente cálido y cómodo en la piscina interior es un básico imprescindible. En este proyecto destaca la combinación de colores y el borde con la rejilla Compact, integrado de manera muy armónica.

Creating a warm and comfortable atmosphere in the indoor pool is an essential. This project highlights the color combination and the edge with the Compact grating, seamlessly integrated.

Créer une ambiance chaleureuse et confortable dans la piscine intérieure est essentiel. Ce projet met en valeur la combinaison de couleurs et le bord avec la grille Compact, intégrés de manière très harmonieuse.

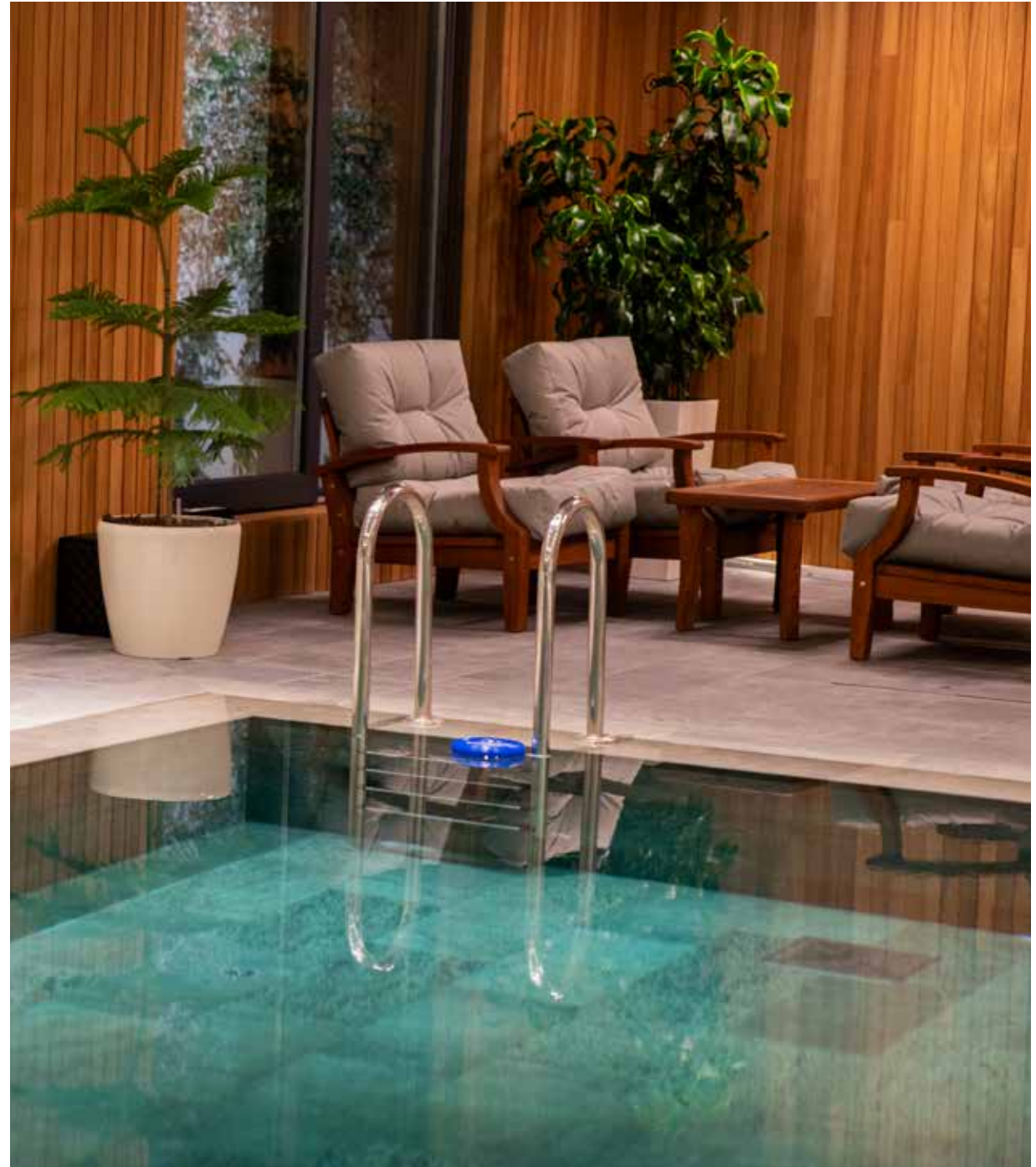









infinity pools

Las piscinas infinity convierten la experiencia visual en algo espectacular. En este diseño la idea se multiplica: dos piscinas a diferentes alturas y una zona spa muy exclusiva que parece suspendida en el paisaje.

Infinity pools turn the visual experience into something spectacular. In this design, the concept is amplified: two pools at different levels and a highly exclusive spa area that appears to float within the landscape.

Les piscines infinity transforment l'expérience visuelle en un spectacle saisissant. Dans ce projet, le concept se déploie : deux piscines à différents niveaux et un espace spa très exclusif qui semble flotter dans le paysage.

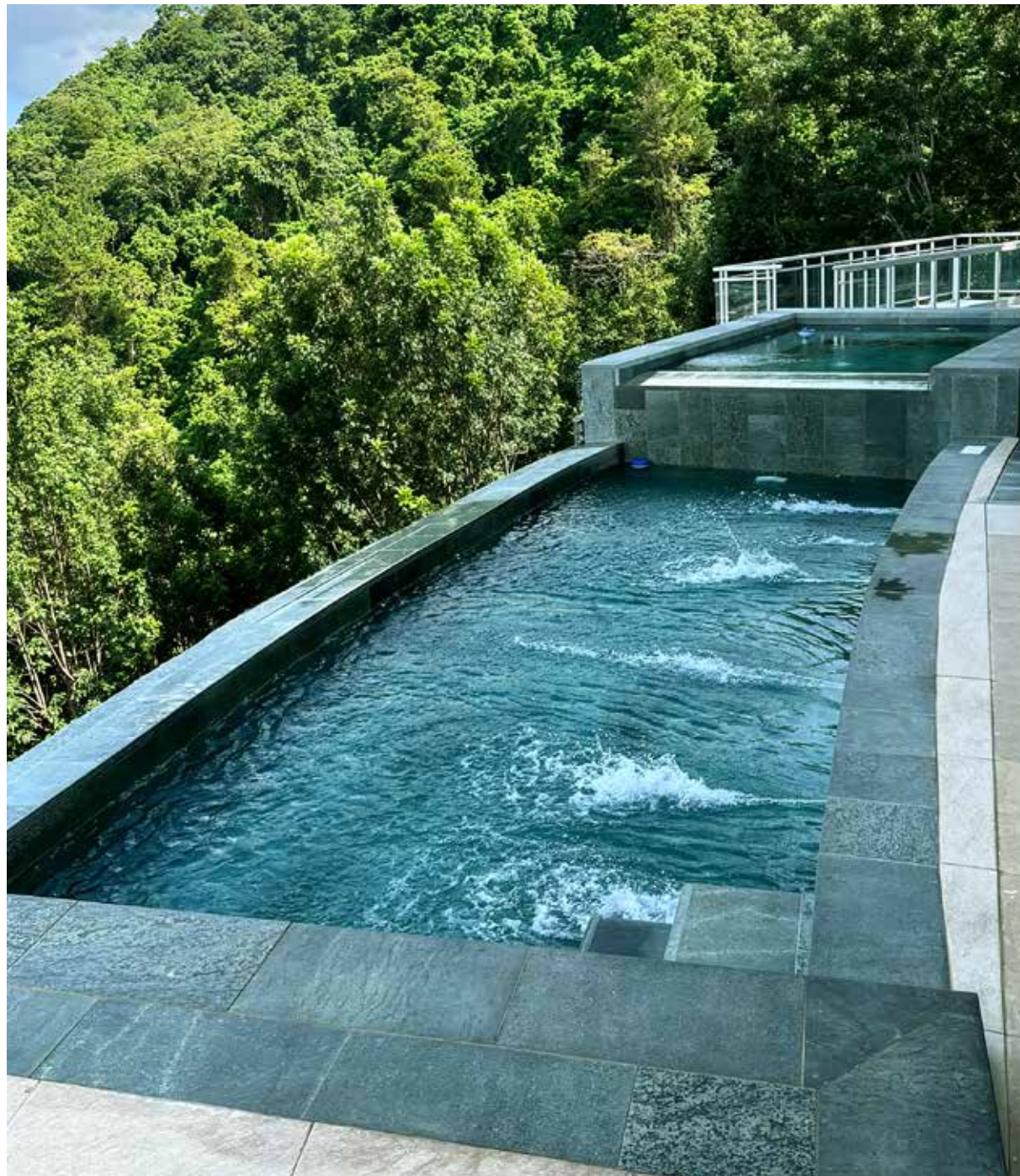





serenity *space*

Un camino que flota sobre el agua, una plataforma sumergida, escaleras de lado a lado y un mix de colores que inspira equilibrio. Elegante, moderno, funcional.

A pathway floating over the water, a submerged platform, side-to-side stairs, and a color mix that inspires balance. Elegant, modern, functional.

Un chemin qui flotte sur l'eau, une plateforme immergée, des escaliers d'un côté à l'autre et un mélange de couleurs qui inspire l'équilibre. Élégant, moderne, fonctionnel.







mix & match *colors*

Piscina con una zona spa diferenciada, tres colores y un detalle arquitectónico singular: escaleras semicirculares acabadas con medias cañas para aumentar la seguridad y el confort.

Pool with a distinct spa area, three colors, and a singular architectural detail: semicircular steps finished with bullnose edges, enhancing both safety and comfort.

Piscine avec une zone spa différenciée, trois couleurs et un détail architectural singulier : escaliers semi-circulaires finis avec des demi-cannes, pour plus de sécurité et de confort.







ceramic *wood*

Colocar madera cerámica en la playa y la terraza es una excelente opción estética que aporta todas las propiedades del gres porcelánico: belleza sin mantenimiento.

Using ceramic wood on the pool deck and terrace is an excellent aesthetic choice, offering all the benefits of porcelain tiles: beauty with no maintenance.

Installer de la céramique imitation bois sur la plage de la piscine et la terrasse est un excellent choix esthétique, offrant toutes les qualités du grès cérame : une beauté sans entretien.

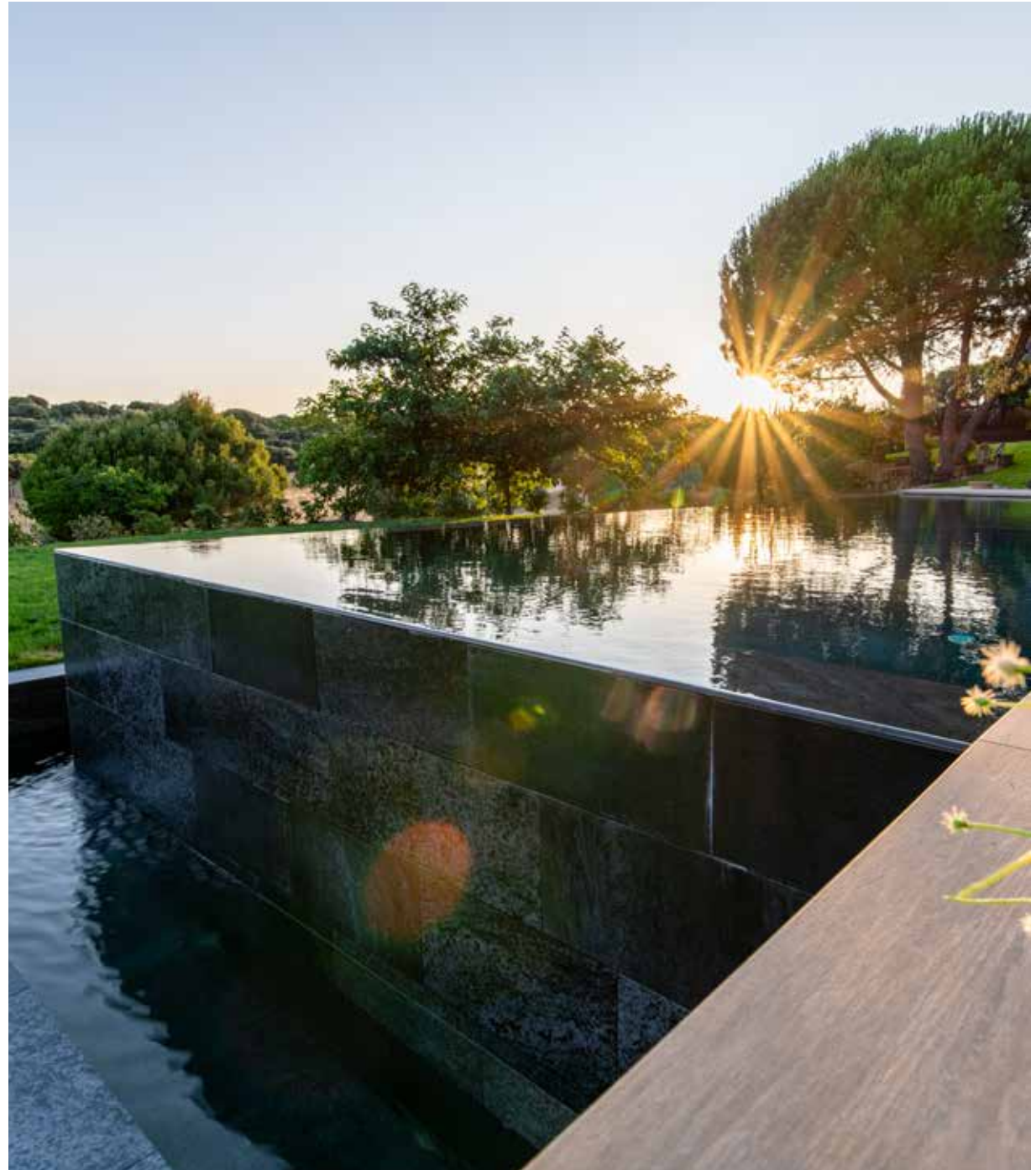





asian *style*

En esta piscina elevada, el color oscuro es la clave para lograr una estética de inspiración exótica que invita al relax. Integra banco, escaleras y jacuzzi de forma armoniosa.

In this elevated pool, the dark color is key to achieving an exotic-inspired aesthetic that invites relaxation. It seamlessly integrates a bench, stairs, and jacuzzi.

Dans cette piscine surélevée, la couleur foncée est la clé pour obtenir une esthétique d'inspiration exotique qui invite à la détente. Elle intègre harmonieusement un banc, des escaliers et un jacuzzi.

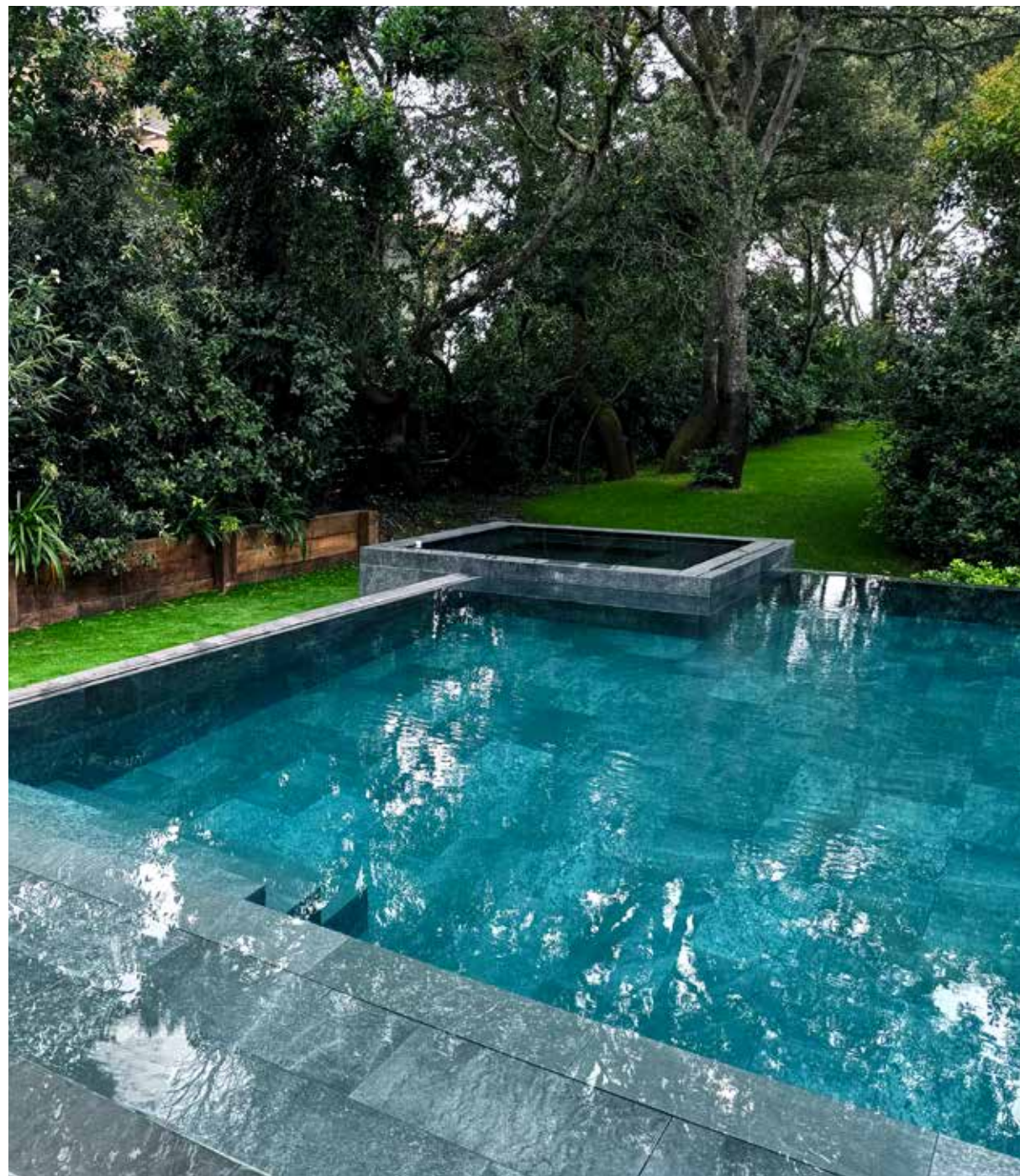





the mirror *effect*

La belleza del cielo reflejado sobre el agua. El efecto espejo se ha conseguido al colocar un tono oscuro en el vaso y nuestro sistema Prestige con la rejilla Compact en el borde. Inolvidable.

The beauty of the sky reflected on the water. The mirror effect is achieved by using a dark tone in the pool and our Prestige system with the Compact grating at the edge. Unforgettable.

La beauté du ciel reflétée sur l'eau. L'effet miroir est obtenu en utilisant une teinte foncée dans le bassin et notre système Prestige avec la grille Compact sur le bord. Inoubliable.

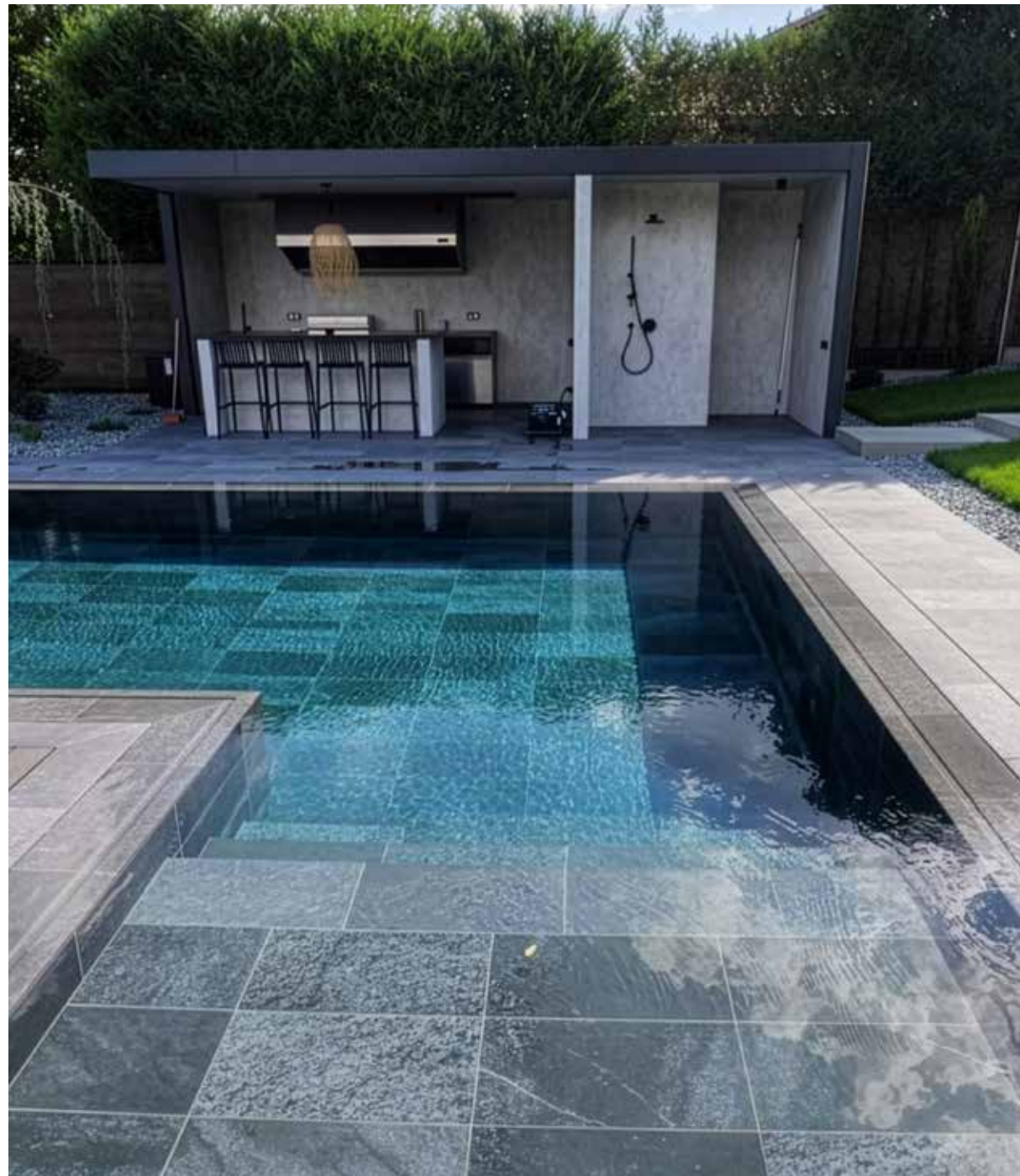













in & out *design*

La armonía es tendencia: al unificar el color del interior, del exterior y de la piscina, se logra un estilo personalizado y la máxima elegancia.

Harmony is trending: by unifying the color of the interior, exterior, and pool, a personalized style and maximum elegance are achieved.

L'harmonie est tendance : en unifiant la couleur de l'intérieur, de l'extérieur et de la piscine, on obtient un style personnalisé et une élégance maximale.

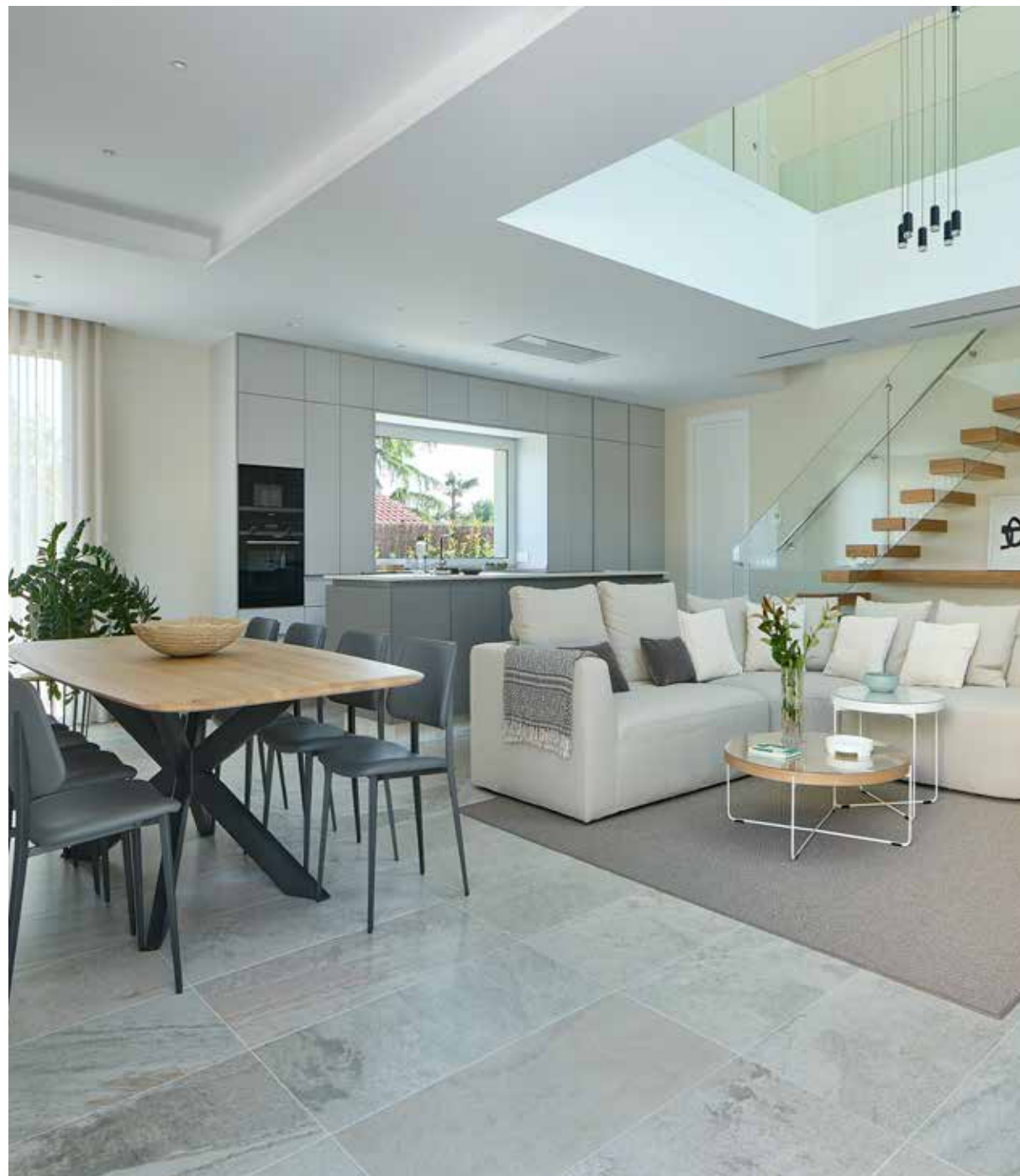

Pietro White & Golden



pool *comfort*

Una zona de relax independiente de la piscina principal, con un banco de cerámica a lo largo de todo el perímetro y escaleras triangulares de acceso.

A relaxation area separate from the main pool, with a ceramic bench running along the entire perimeter and triangular access stairs.

Une zone de détente indépendante de la piscine principale, avec un banc en céramique tout le long du périmètre et des escaliers triangulaires d'accès.

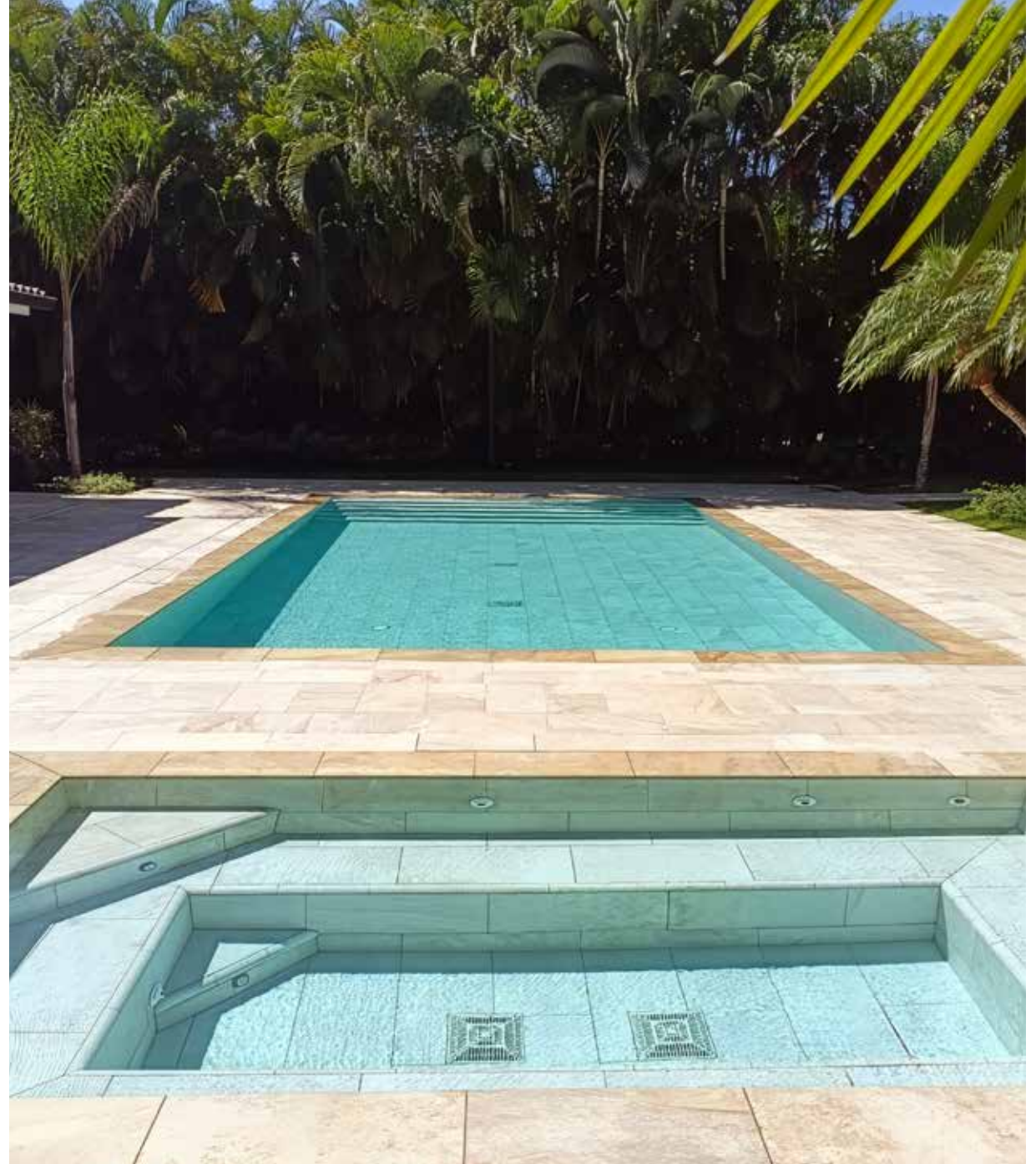



black & white *style*

Un juego de colores tan esencial que no pasa de moda. La piscina es desbordante y acabada con la rejilla Compact para reforzar la continuidad entre el borde y la playa.

Timeless colors. An overflow pool with the Compact grating creates a seamless transition from edge to pool deck.

Un jeu de couleurs si essentiel qu'il ne se démode jamais.
Il s'agit d'une piscine à débordement finie avec la grille Compact pour renforcer la continuité entre le bord et la plage.

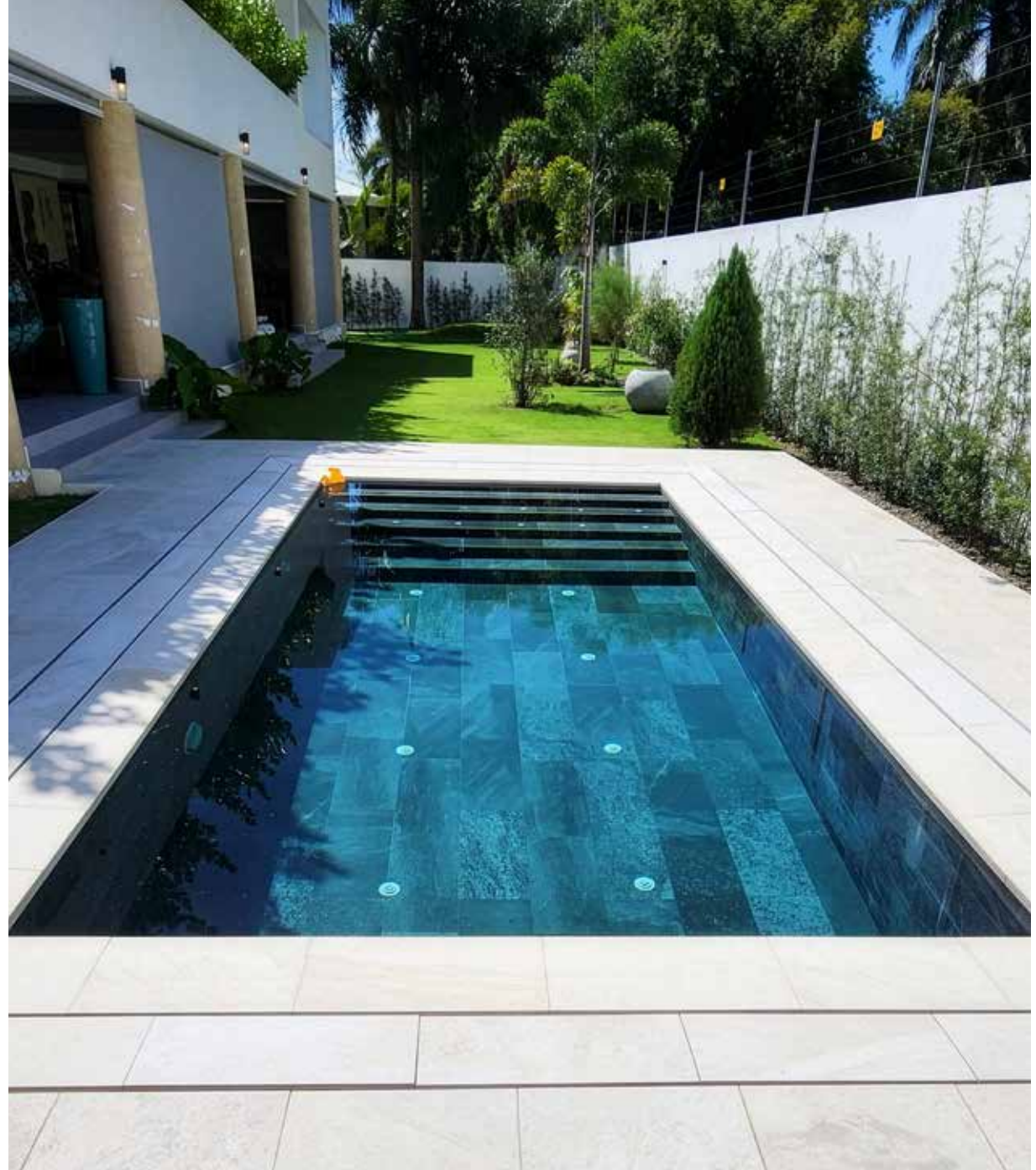



color solutions

El tono Pietro Golden en la terraza actúa como transición visual entre el muro de piedra y la piscina. La selección de colores elegidos armoniza la estética del exterior y aporta elegancia.

The Pietro Golden tone on the terrace acts as a visual transition between the stone wall and the pool.

The selected color palette harmonizes the outdoor aesthetics and adds elegance.

La tonalidad Pietro Golden sur la terrasse sert de transition visuelle entre le mur en pierre et la piscine.

La sélection des couleurs choisies harmonise l'esthétique de l'extérieur et apporte élégance.

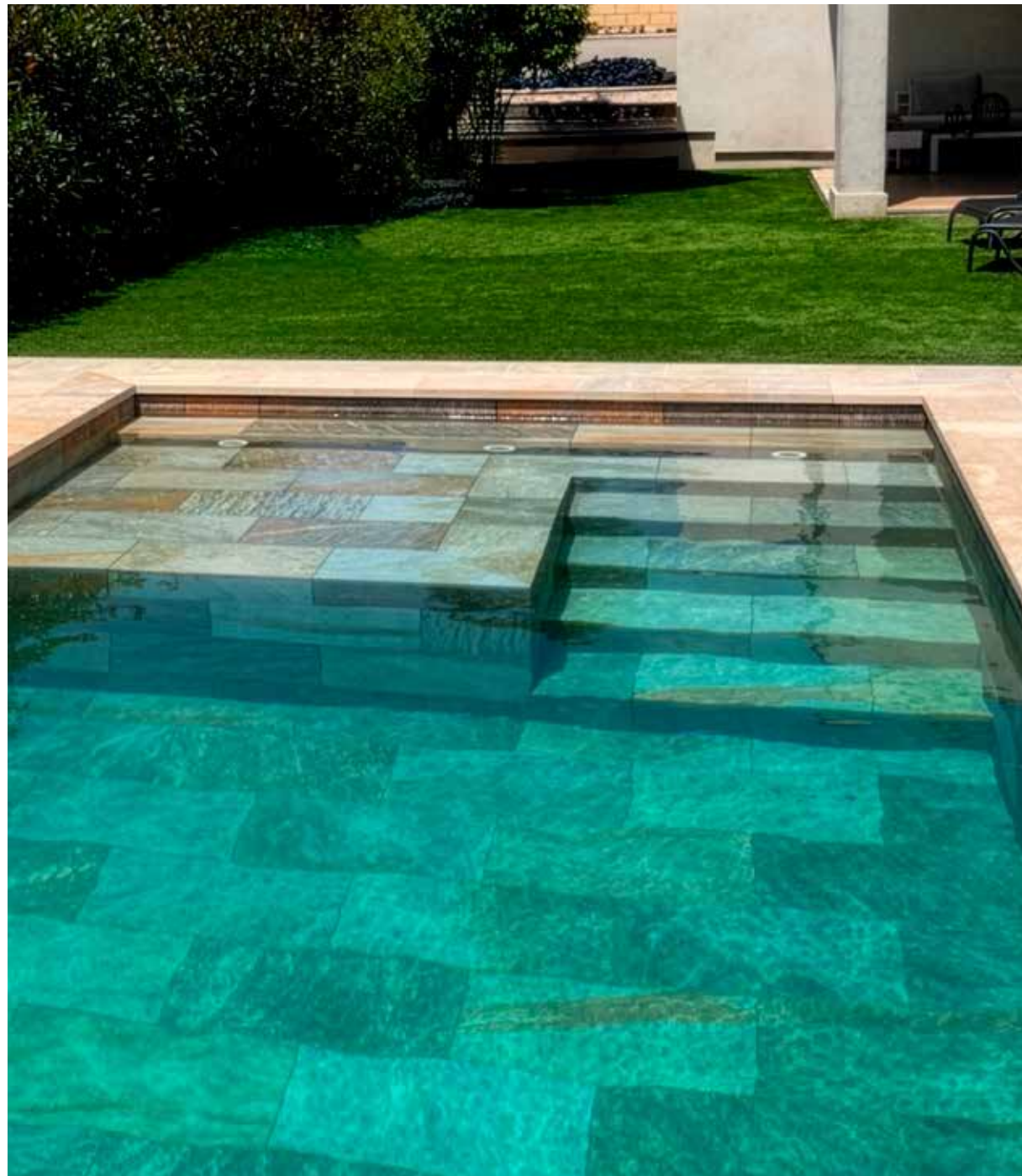



Smart ideas

Una piscina que, con tan solo **2,5 x 4 m**, aumenta el valor de la vivienda. Destaca la armonía estética y la combinación de colores de todos los elementos del jardín.

A 2.5 x 4 m pool that adds value to the property. Highlights include its aesthetic harmony and the coordinated colors of all garden elements.

Une piscine de 2,5 x 4 m qui valorise la propriété. Elle se distingue par l'harmonie esthétique et la coordination des couleurs de tous les éléments du jardin.

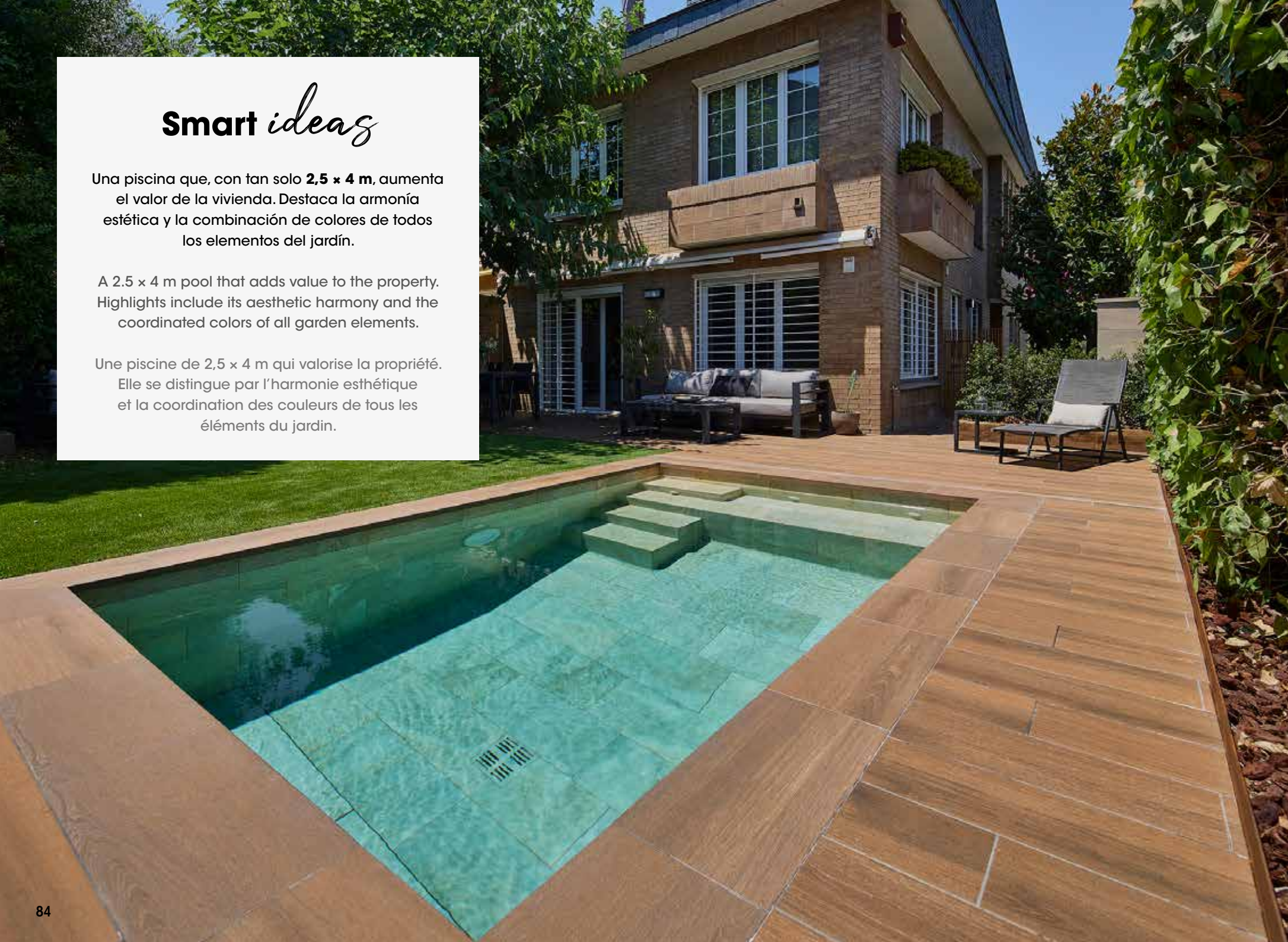

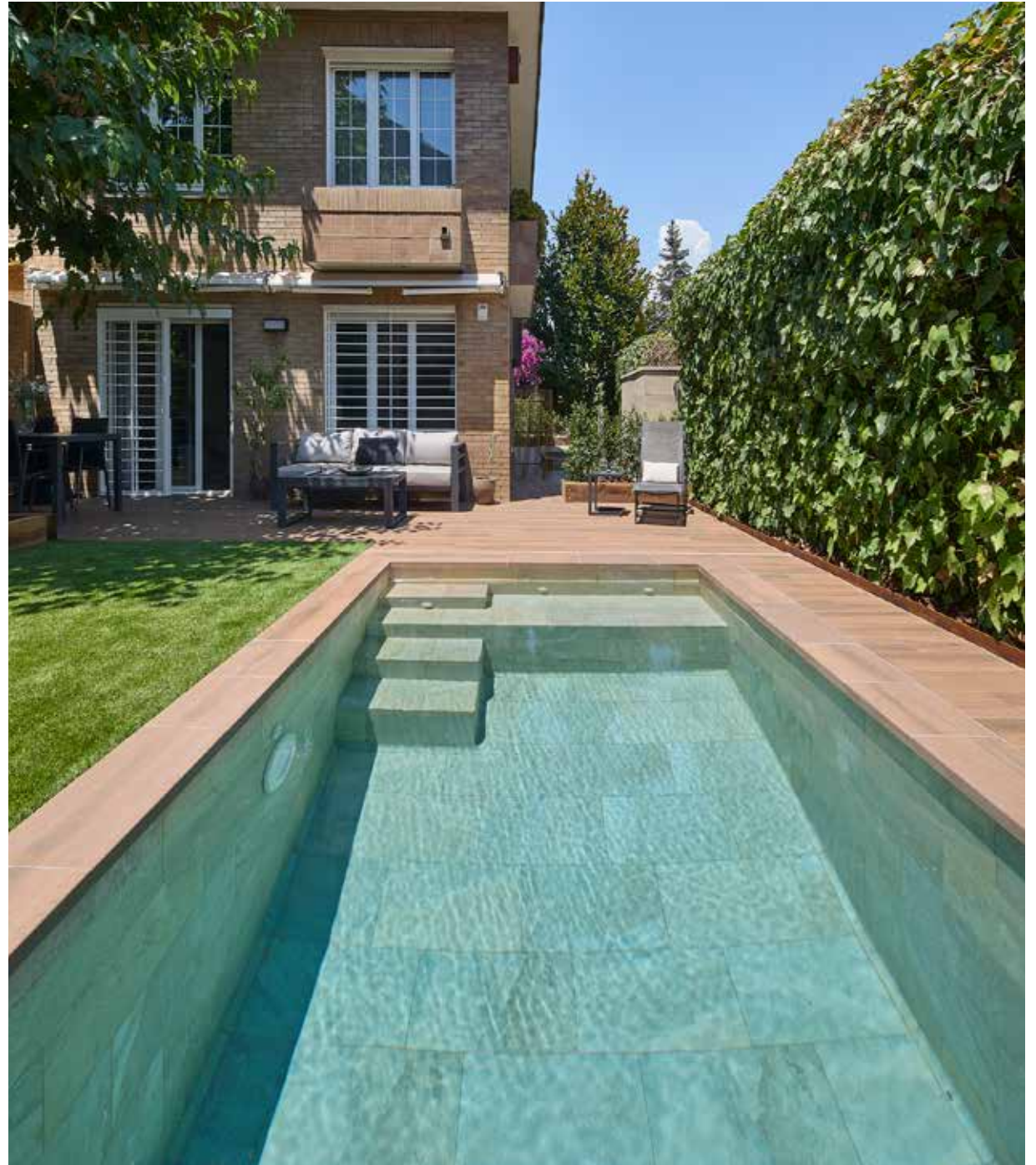





small pool *inspiration*

Como adaptarse al espacio sin perder estilo: integrar banco y escaleras, crear un muro para la cascada y combinar dos tonos complementarios que realzan el color del agua.

How to adapt to the space without losing style: integrate the bench and stairs, create a wall for the waterfall, and blend two complementary tones to enhance the color of the water.

Comment s'adapter à l'espace sans perdre de style : intégrer le banc et les escaliers, créer un mur pour la cascade et combiner deux tons complémentaires qui rehaussent la couleur de l'eau.

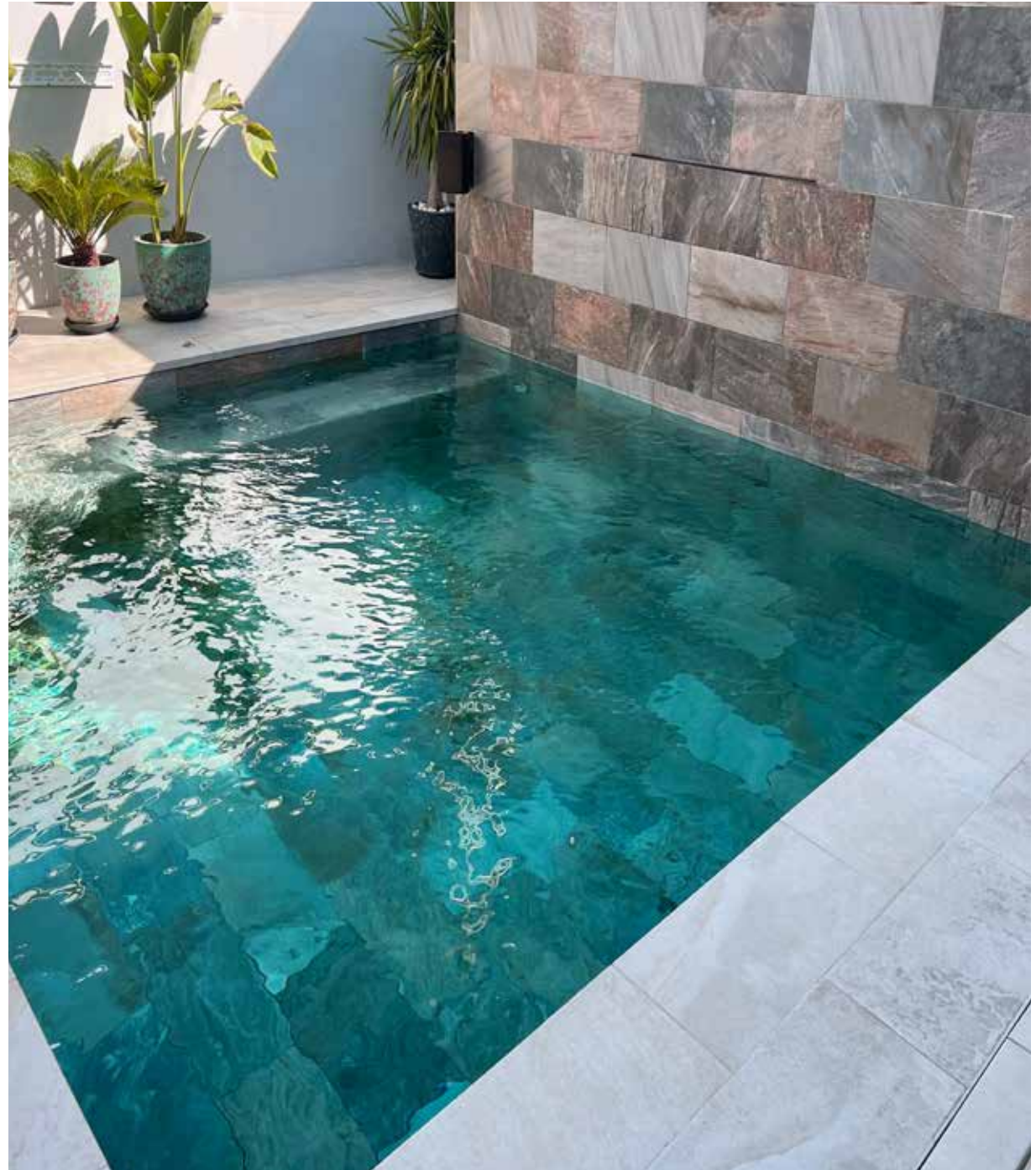







comfort *ideas*

Piscina elevada con una amplia plataforma sumergida. Las esquinas se han rematado con piezas acabadas en curva, para disfrutar de la máxima seguridad y bienestar.

Elevated pool with a large submerged platform. The corners are finished with half round pieces, ensuring maximum safety and comfort.

Piscine surélevée avec une grande plateforme immergée. Les angles ont été finis avec des demi-cannes, pour offrir un maximum de sécurité et de confort.

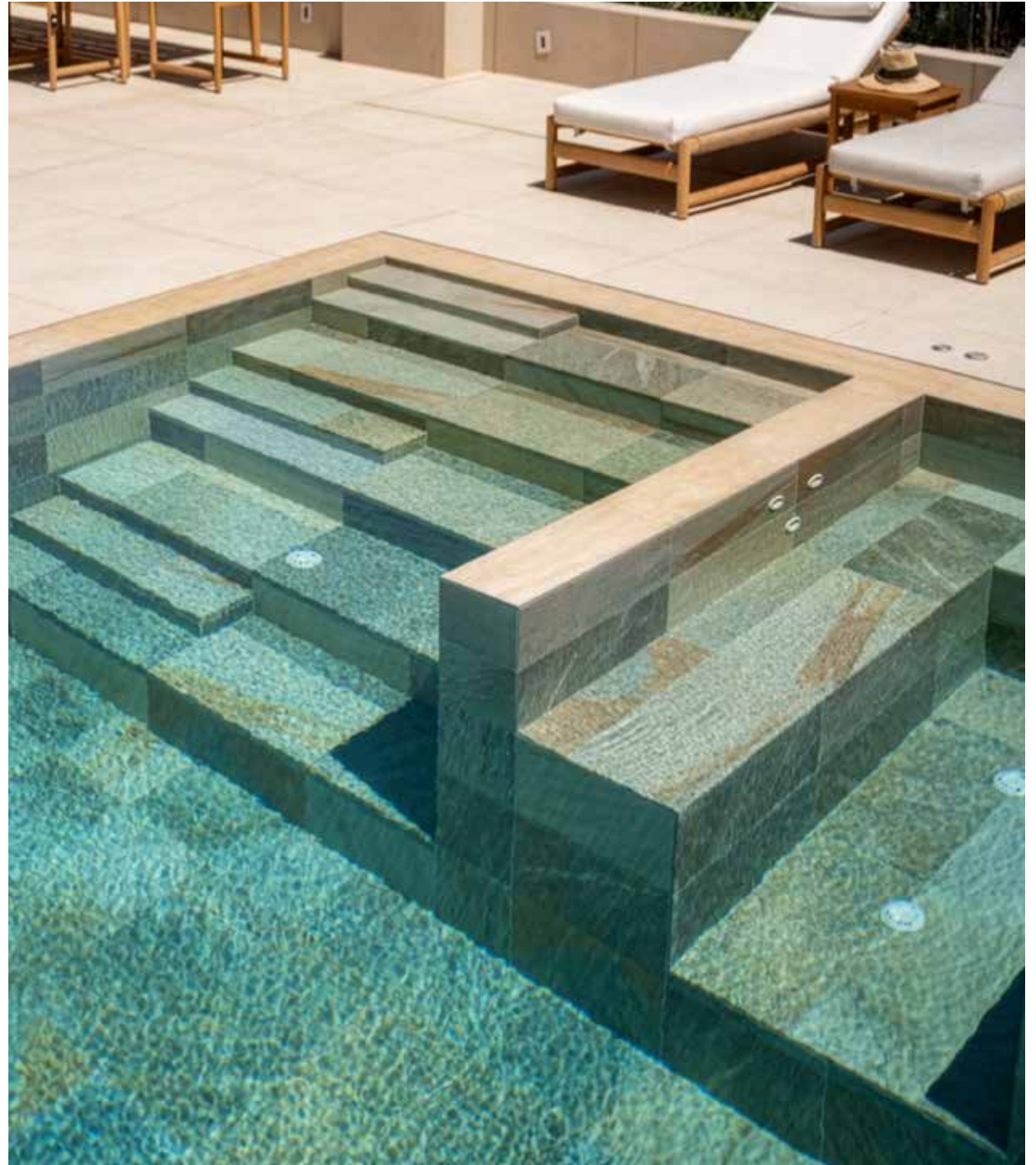





small pool *essentials*

Un diseño ideal para espacios pequeños: líneas rectas, banco integrado, escaleras sumergidas y una combinación de colores moderna y elegante.

An ideal design for small spaces: clean lines, integrated bench, submerged steps, and a modern, stylish color combination.

Un design idéal pour les petits espaces : lignes droites, banc intégré, escaliers immergés et combinaison de couleurs moderne et élégante.











Mistery Grey

Design: Eva Vidal, Taller de paisatge / Spain





Unique Pools Comfort Solutions

Piscina skimmer | Skimmer Pool | Piscine skimmer

«L» SOLUTION | PIEZAS DE BORDE | EDGE TILES | MARGELLES



L62 62,6 x 31,7 x 3,8



L98 97,9 x 31,7 x 3,8



E62 62,6 x 62,6 x 3,8



E98 97,9 X 97,9 x 3,8



DL1 31,7 x 31,7 x 3,8

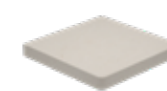

DL2 31,7 x 31,7 x 3,8



«S» SOLUTION | PIEZAS DE BORDE | EDGE TILES | MARGELLES



S62 62,6 x 31 x 2,6



S13 46 x 46 x 2,6



DS1 31 x 31 x 2,6



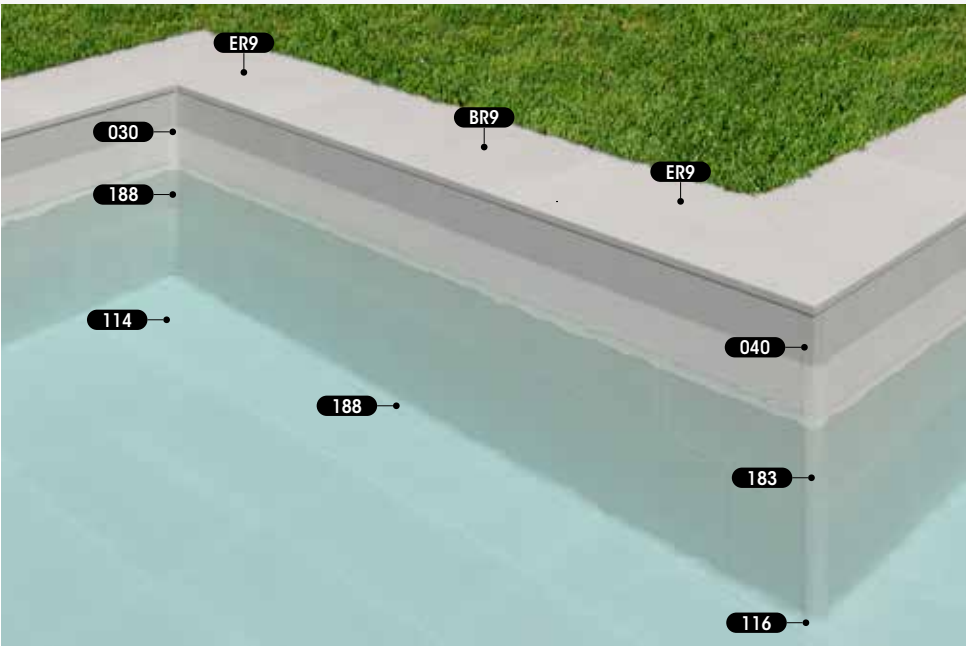

BR6 62,6 x 50 x 2,6



ER6 62,6 x 62,6 x 50 x 2,6



BR9 97,9 x 50 x 2,6



ER9 97,9 x 97,9 x 50 x 2,6

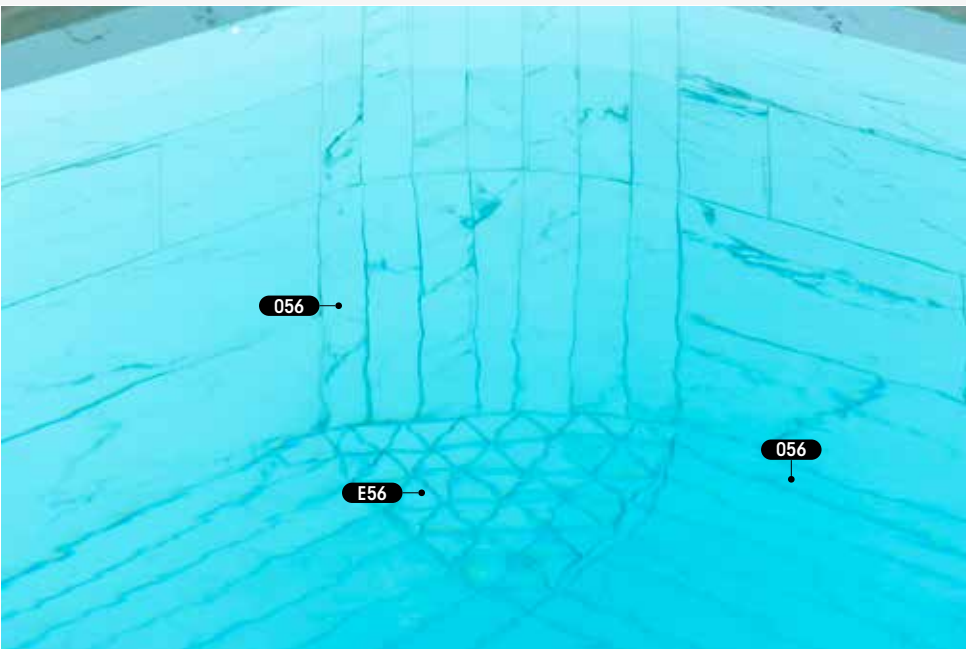

056 62,6 x 5 x 0,9

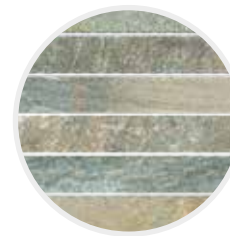

E56 5 x 4,3 x 0,9



PRESTIGE SYSTEM | PIEZAS DE BORDE | EDGE TILES | MARGELLES

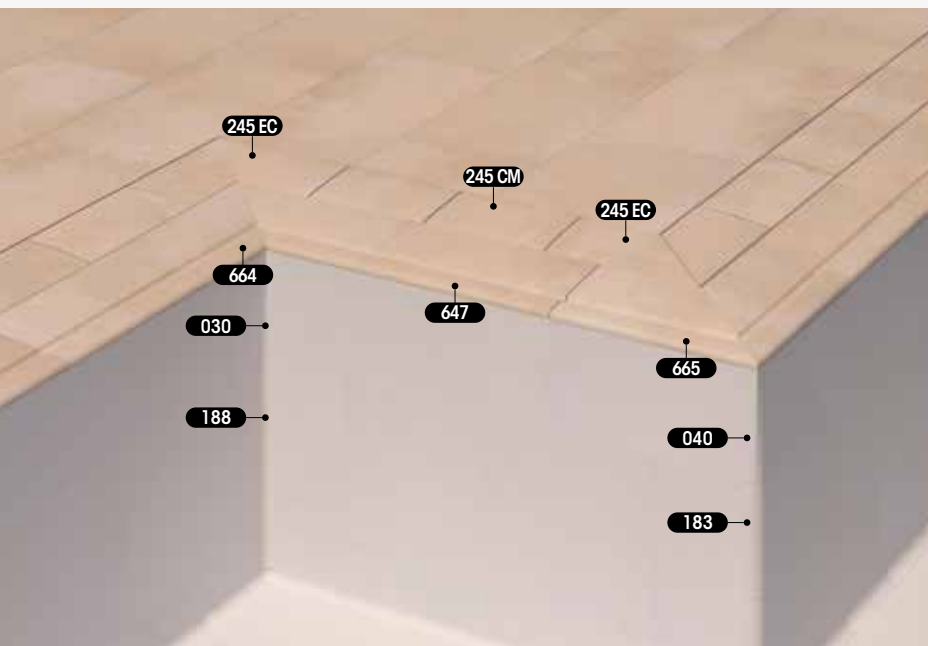

647 62,6 x 31 x 2,6



E65 31 x 31 x 2,6



664 62,6 x 62,6 x 2,6



665 62,6 x 62,6 x 2,6



SLIM SYSTEM | PIEZAS DE BORDE | EDGE TILES | MARGELLES

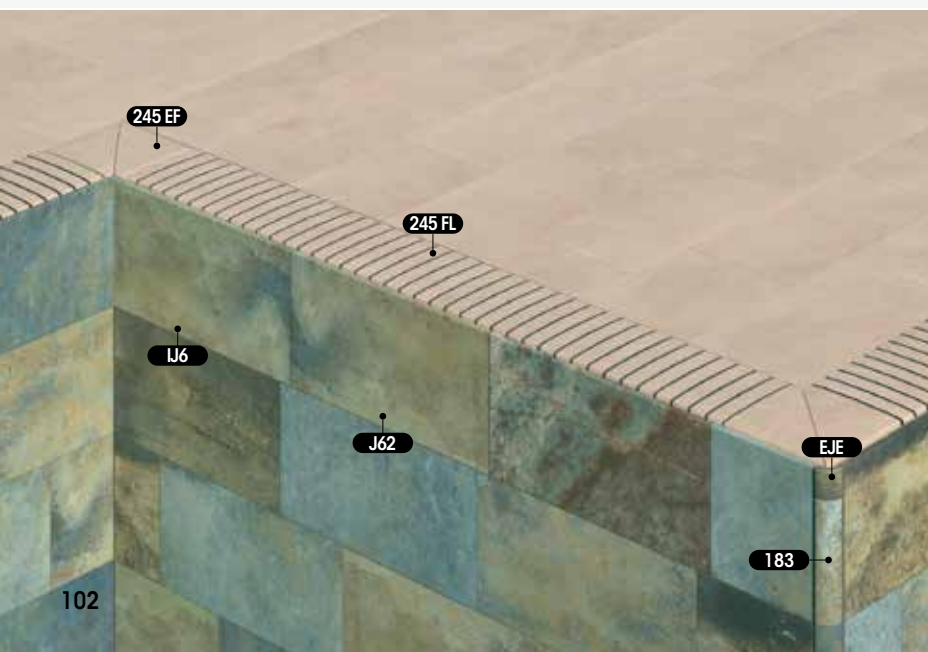

J62 62,6 x 31 x 3,8



IJ6 31 x 31 x 31



EJE 4 x 4





Rejilla Flex | Flex Grating | Grille Flex



- Se compone por distintas piezas unidas sin adhesivos entre sí y que mantienen una separación constante.
- Su diseño ofrece una excelente adaptabilidad a las curvas.
- Gracias a su estructura en forma de trapecio logra evitar el puente de agua incluso si no se coloca correctamente.
- Facilita la reposición de piezas sueltas.
- Puede desmontarse para separar y reciclar cada una de sus partes.

245 FL 49,5 x 24,5 x 2,2



245 EF 26,6 x 26,6 x 2,2



- It is made up of different pieces joined together without adhesives and maintaining a constant separation.
- Its design provides outstanding adaptability to curves.
- Thanks to its trapezoid-shaped structure, it avoids the water bridge even if it is not positioned correctly.
- Its different parts are easy to replace.
- It can be disassembled to separate and recycle each of its parts individually.

- Elle est composée de différentes pièces assemblées sans adhésifs et qui maintiennent une distance constante.
- Son design lui permet de très bien s'adapter aux courbures.
- Grâce à sa structure trapézoïdale, elle évite les débordements d'eau même si elle n'est pas positionnée correctement.
- Le remplacement des pièces est très facile.
- Elle peut être démontée, ce qui permet de séparer et de recycler chacun de ses composants.

Rejilla Compact | Compact Grating | Grille Compact



- Consiste en una sola pieza fabricada sin adhesivos.
- Una vez colocada queda totalmente integrada con el borde.
- El desagüe se realiza a través de un sistema de orificios laterales apenas visibles pero con una capacidad adecuada de evacuación.
- Facilita la reposición de piezas sueltas.
- Su diseño es ligeramente convexo para laminar el flujo de agua y aumentar su recogida.

245 CM 62,6 x 24,5 x 2,2

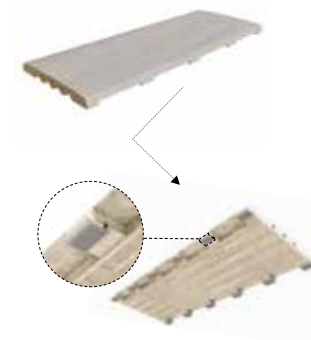

- It consists of a single piece manufactured without adhesives.
- Once in place, it integrates seamlessly with the edge.
- Drainage occurs through a system of barely noticeable lateral holes, but with sufficient drainage capacity.
- Its different parts are easy to replace.
- Its design is slightly convex to laminate water flow and increase water collection.

245 EC 62,6 x 62,6 x 2,2



- Elle est constituée d'une seule pièce fabriquée sans adhésif.
- Une fois mise en place, elle s'intègre parfaitement au bord.
- L'évacuation s'effectue à l'aide d'un système d'orifices latéraux à peine visibles mais offrant une capacité de drainage bien adaptée.
- Le remplacement des pièces est très facile.
- Son design légèrement convexe permet de laminar l'écoulement de l'eau et d'augmenter sa collecte.

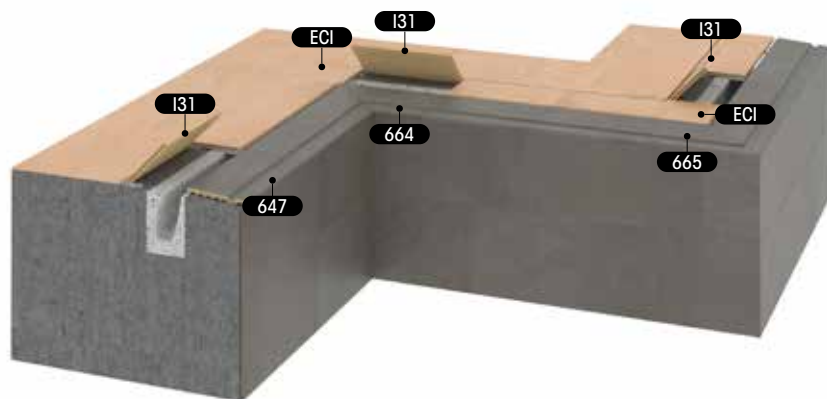

I31 62,6 x 31 x 2,6



ECI 34,5 x 34,5 x 2,6



647 62,6 x 31 x 2,6



664 62,6 x 62,6 x 2,6



E65 31 x 31 x 2,6



665 62,6 x 62,6 x 2,6

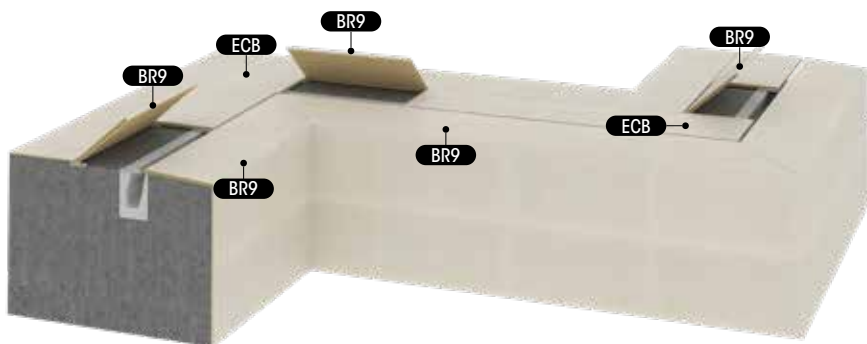
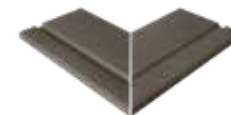

BR6 62,6 x 50 x 2,6



ER6 62,6 x 62,6 x 50 x 2,6



BR9 97,9 x 50 x 2,6



ECB 52,8 x 52,8 2,6

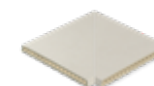

Piscina desbordante | Deck level pool | Piscine à débordement

ZEN SYSTEM | PIEZAS DE BORDE | EDGE TILES | MARGELLES

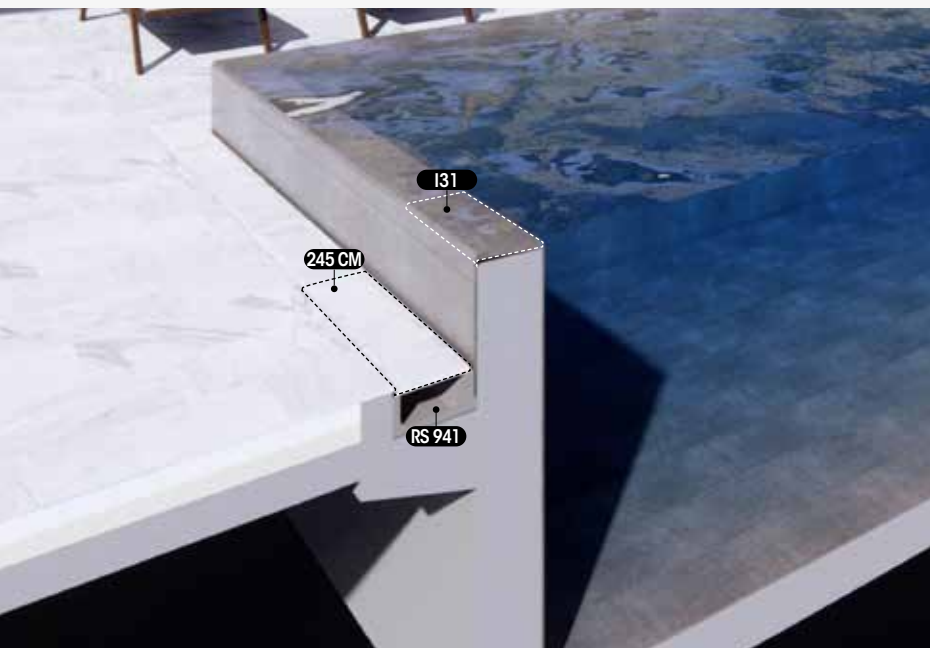

Piscina con desborde perimetral elevado / Raised perimeter overflow pool / Piscine à débordement périmétrique surélevée

131 62,6 x 31 x 2,6



245 CM 62,6 x 24,5 x 2,2



ERGO SYSTEM | PIEZAS DE BORDE | EDGE TILES | MARGELLES



616 62,6 x 26,2 x 3,7



IEP 62,6 x 62,6 x 3,7



EEP 62,6 x 62,6 x 3,7



110 24,4 x 2,5



Piscina desbordante | Deck level pool | Piscine à débordement

SMART SYSTEM | PIEZAS DE BORDE | EDGE TILES | MARGELLES

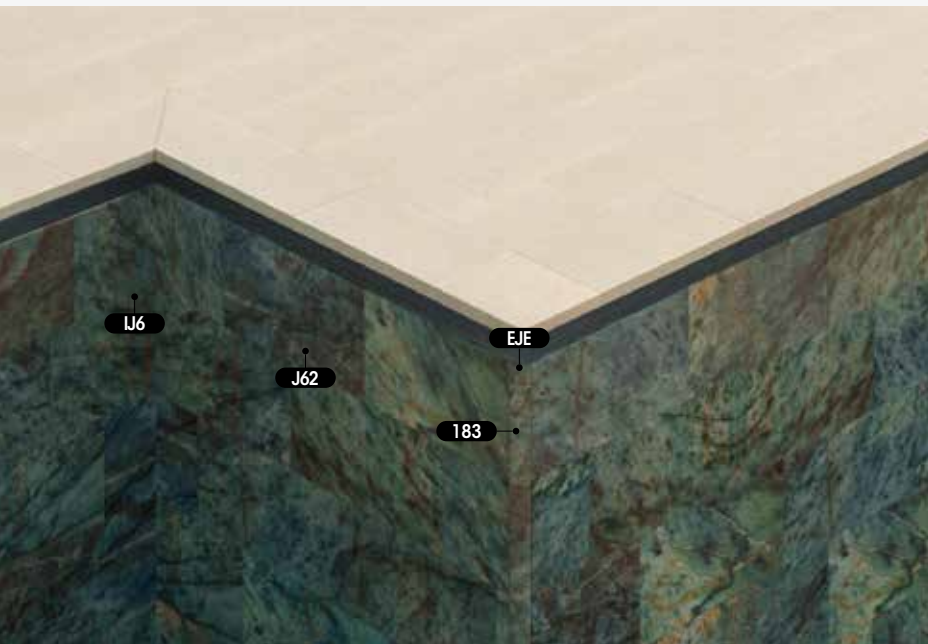

J62 62,6 x 31 x 3,8



IJ6 31 x 31 x 31



EJE 4 x 4



INFINITY SOLUTION | PIEZAS DE BORDE | EDGE TILES | MARGELLES



I31 62,6 x 31 x 2,6



MEDIAS CAÑAS | HALF ROUND PIECES | DEMI-CANNES

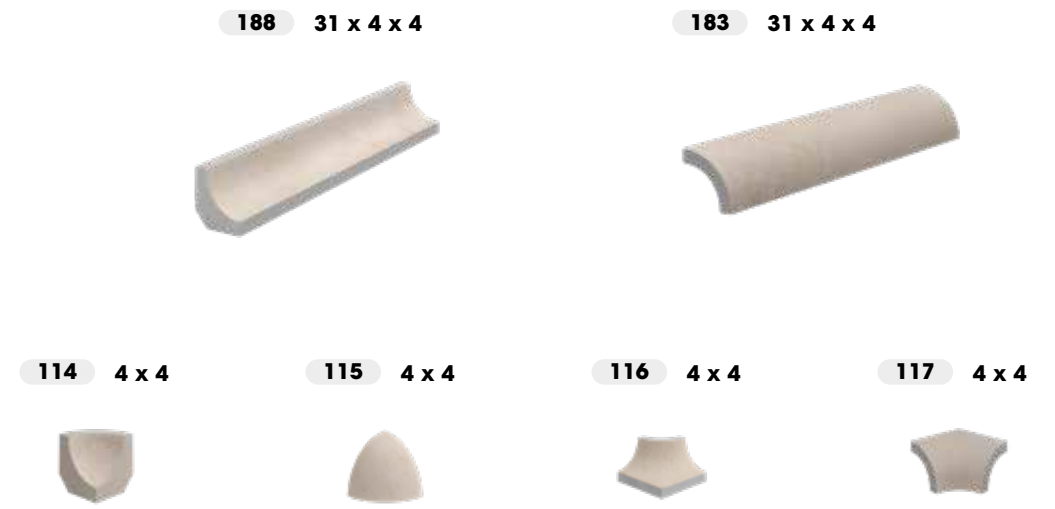
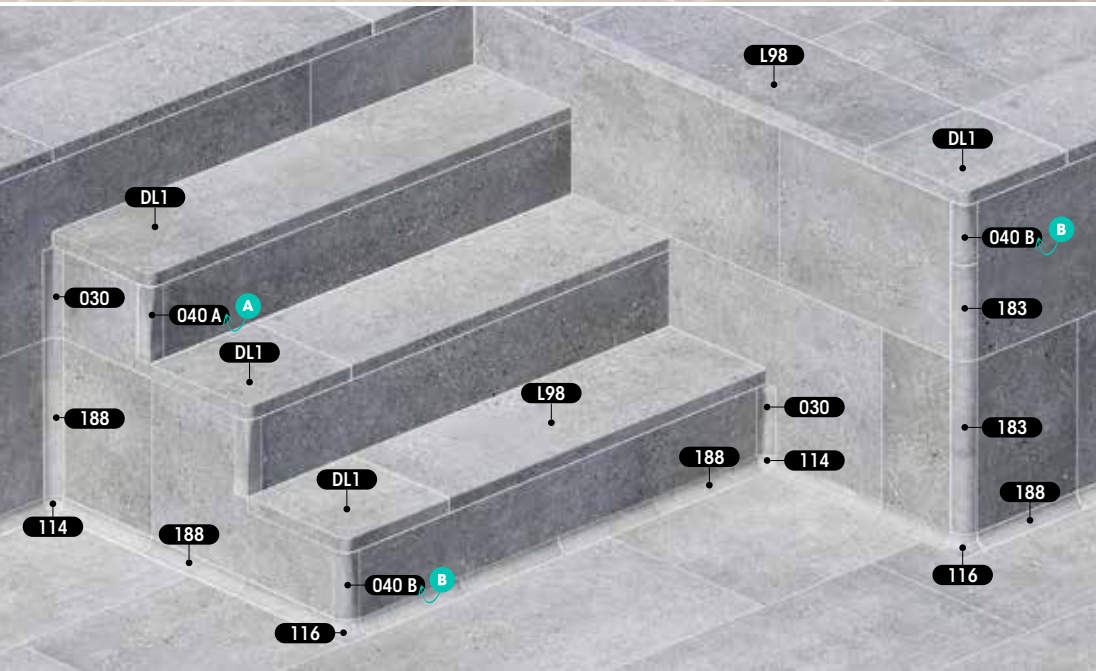





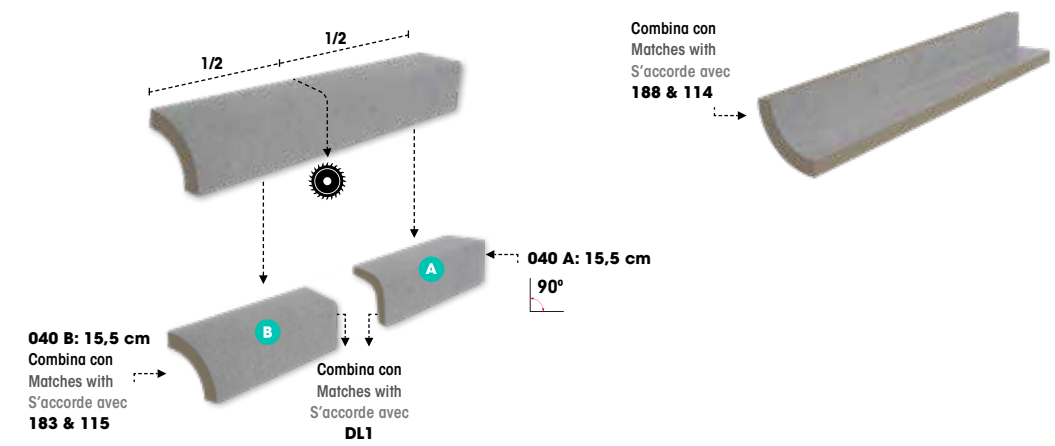

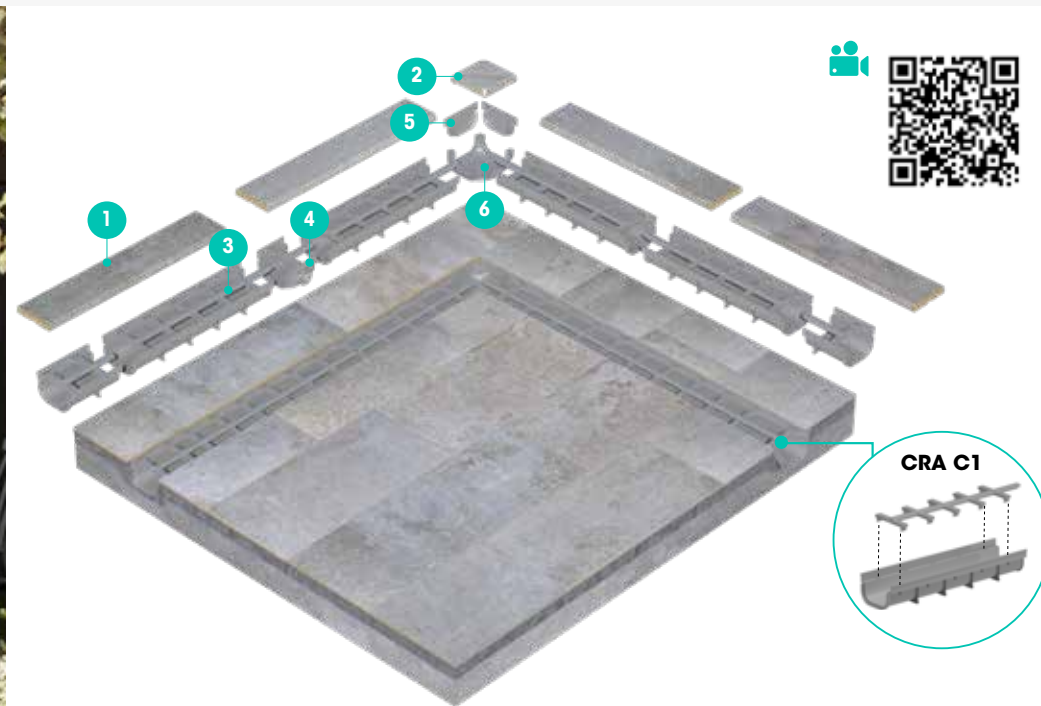
040 31 x 4 x 4 Para esquinas exteriores
For outer corners
Pour angles extérieurs

030 31 x 4 x 4 Para esquinas interiores
For inner corners
Pour angles intérieurs





121 CM 62,6 x 12,5 x 2,2

- | | | | | | |
|--|---|--|--|--|--|
|  <p>1
121 CM Anti-Slip
62,6 x 12,5 x 2,2</p> |  <p>2
E21 Anti-Slip
12,5 x 12,5 x 2,2</p> |  <p>3
CRA C1
50 x 13 x 7,5</p> |  <p>4
DCR C1</p> |  <p>5
TCR C1</p> |  <p>6
CCR C1</p> |
|--|---|--|--|--|--|



DL1 31,7 x 31,7 x 3,8



Z62 62,6 x 7



ZLI **ZLD** 36,5 x 30 x 7



L62 62,6 x 31,7 x 3,8



L98 97,9 x 31,7 x 3,8



DL2 31,7 x 31,7 x 3,8

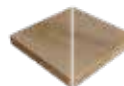

ED6 62,6 x 31,7 x 3,8

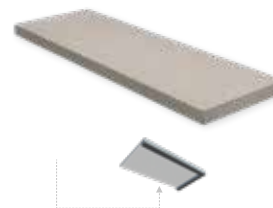

ED9 97,9 x 31,7 x 3,8



EI6 62,6 x 31,7 x 3,8



EI9 97,9 x 31,7 x 3,8





Personaliza tu piscina

Combina y cambia los colores de tu piscina para descubrir tu diseño favorito

Personalize your pool

Change and combine the colors of your pool to discover your favorite design

Personnalisez votre piscine

Changez et combinez les couleurs de votre piscine pour découvrir votre design préféré



S9 PRESTIGE



S9 SLIM



S9 SMART

SISTEMA 9

La solución de Rosa Gres para construir piscinas desbordantes privadas de forma sencilla, ágil y eficiente.

ES



SYSTEM 9

Rosa Gres solution for the quick, simple and efficient construction of private deck-level pools.

EN



SYSTÈME 9

La solution de Rosa Gres pour construire des piscines privées à débordement de façon simple, rapide et efficace.

FR



zero
problems
pools

CÓMO CONSTRUIR PISCINAS
ZERO PROBLEMS
Consúltanos

HOW TO BUILD
ZERO PROBLEMS POOLS
Ask us

COMMENT CONSTRUIRE
DES PISCINES ZERO PROBLEMS
Consultez-nous



JUNTAS DE COLOCACIÓN
FIXCER RECOMENDADAS
PARA LOS COLORES DE LAS
COLECCIONES ROSA GRES

RECOMMENDED FIXCER
MORTAR JOINTS FOR
COLOURS FROM THE
ROSA GRES COLLECTIONS

MORTIERS DE JOINTIEMENT
FIXCER RECOMMANDÉS
POUR LES COULEURS DES
COLLECTIONS ROSA GRES

IDEAL COLOR / IDEAL POOL

0 Blanco	25 Humo
1 Beige *	28 Plomo
8 Gris claro *	40 Blanco Miami
9 Gris cemento *	46 Piedra *
10 Antracita *	48 Marrón arena *
11 Negro *	

CERPOXI / PROFESSIONAL PX

0 Blanco	8 Gris Claro
2 Beige oscuro	9 Gris cemento
3 Beige Natural	10 Antracita
4 Marrón claro	11 Negro

Ⓞ Colores Ideal Pool disponibles
Ⓞ Available Ideal Pool colours
Ⓞ Couleurs Ideal Pool disponibles

NORMA DE ENSAYO / TESTING STANDARD / NORME D'ESSAI			REGULACIÓN / REGULATION / RÉGLEMENTATION EN 14411 - ISO 13006		Rosa Gres	
					Alma - Coral - Cuore - Iconic Mistery - Mythos - Pietro - Serena Sophy - Stela - Trésor	Pietro 2 cm Iconic 2 cm
	ISO 10545 - 2	Características dimensionales Dimensions and surface quality Dimensions et aspect de la surface	Exigida Required Exigée		Garantizada Guaranteed Garantie	Garantizada Guaranteed Garantie
	ISO 10545 - 3	Absorción de agua Water absorption Absorption d'eau	Grupo B1a Grupo A1a E ≤ 0,5 %		E ≤ 0,5 %	E ≤ 0,5 %
	ISO 10545 - 4	Fuerza de rotura Breaking strength Effort à la rupture	≥ 1.300 N		≥ 1.300 N	≥ 8.000 N
		Resistencia a la flexión Modulus of rupture Résistance à la flexion	Grupo A1a 28 N/mm ² Grupo B1a 35 N/mm ²		≥ 35 N/mm ²	≥ 35 N/mm ²
	ISO 10545 - 9	Resistencia al choque térmico Thermal shock resistance Résistance aux chocs thermiques	Exigida Required Exigée		Garantizada Guaranteed Garantie	Garantizada Guaranteed Garantie
	ISO 10545 - 12	Resistencia a la helada Frost resistance Résistance au gel	Exigida Required Exigée		Garantizada Guaranteed Garantie	Garantizada Guaranteed Garantie
	ISO 10545 - 13	Resistencia química ⁽¹⁾ Chemical resistance ⁽¹⁾ Résistance chimique ⁽¹⁾	Min. Clase B		A LA HA	A LA HA
	ISO 10545 - 14	Resistencia a las manchas Stain resistance Résistance aux tâches	Min. Clase 3		Garantizada Guaranteed Garantie	Garantizada Guaranteed Garantie

⁽¹⁾ Excepto ácido fluorhídrico y sus compuestos / Except hydrofluoric acid and its components / A l'exception de l'acide fluorhydrique et ses composés

Piezas base: grupo B1a / Field tiles: group B1a / Pièces de base: groupe B1a

Piezas especiales: grupo A1a / Trim pieces: group A1a / Pièces spéciales: groupe A1a

SEGURIDAD / SAFETY / SÉCURITÉ

REGULACIÓN / REGULATION / RÉGLEMENTATION EN 16165

COEFICIENTES DE ANTIDESLIZAMIENTO / NON-SLIP COEFFICIENTS / COEFFICIENTS DE RÉSISTANCE			LISO / SMOOTH FINISH / FINITIONS LISSES		ANTIDESLIZANTE / ANTI-SLIP FINISH / FINITIONS ANTIDÉRAPANTES	
	EN 16165 Anexo A (DIN 51097)	Norma para pie descalzo Norm for barefoot traffic areas Norme pour pieds nus	-		Clase C ≥ 24°	Alma - Coral - Cuore - Iconic - Mistery - Mythos Pietro - Serena - Sophy - Stela - Trésor
	EN 16165 Anexo B (DIN 51130)	Norma para pie calzado Norm for footwear traffic areas Norme pour pieds chaussés	-		R10 > 10° - 19°	Trésor
	EN 16165 Anexo C (AN - 2 - 6)	Pendulum Test	Clase 1 15 < Rd ≤ 35	Cuore - Iconic Mistery - Mythos Pietro - Serena - Sophy	Clase 3 Rd > 45	Alma - Coral - Cuore - Iconic - Mistery - Mythos Pietro - Serena - Sophy - Stela - Trésor
ANSI A - 326 - 3 (ANSI 1317 - 1)		Coefficiente de fricción Coefficient of friction Coefficient de friction	-		Exterior wet ≥ 0,55	Alma - Coral - Cuore - Iconic - Mistery - Mythos Pietro - Serena - Sophy - Stela - Trésor



Portada y contraportada | Cover and back cover | Couverture et quatrième de couverture: **Alma Honey & Trésor Bali** / Photograph: Jordi Miralles



Rosa Gres, SLU

Oficina Central - Central office - Bureau Central

Ctra. Sant Cugat, km. 3
08290 Cerdanyola, Barcelona, Spain
Tel. + 34 93 586 30 60
Ventas: + 34 93 586 37 00
Export Sales: + 34 93 586 37 02
info@rosagres.com
www.rosagres.com

Fábrica - Factory - Fabrique

Pol. Ind. Mas Vell
Ramón Sugrañes, 1
43144 Vallmoll, Tarragona, Spain

Rosa Gres France, SARL

64140 Lons, France
Tel. + 00 33 411 92 00 30
contact@rosagres.com
administration@rosagres.com
www.rosagres.com/fr

